Limited Assurance Report

COCIR European Coordination Committee of the Radiological,
Electromedical and Healthcare (IT) Industry, SRI Steering Committee
Secretariat
Brussels

Review of the SRI Status Report 2015

Contract: 0.0791077.001



Independent Practitioner's Limited Assurance Report

To the European Coordination Committee of the Radiological, Electromedical and Healthcare IT Industry ("COCIR"), the SRI Steering Committee Secretariat of the Self-Regulatory Initiative ("SRI") for Medical Imaging Equipment under the Ecodesign Directive, Brussels.

We have been engaged to perform a limited assurance engagement on selected data marked with ✓ in the Status Report of the SRI for Medical Imaging Equipment under the Ecodesign Directive (hereafter the "SRI Status Report"), Brussels, for the year 2015 in the context of the reporting requirements of the SRI.

Management's Responsibility

The SRI Steering Committee Secretariat of the SRI is responsible for the preparation and presentation of the SRI Status Report in accordance with the six step methodology as stated in the SRI V1 (for ultrasound imaging equipment) and SRI V3 (for MRI, CT and future modalities) (hereafter the "SRI six step methodology"):

- Step 1: Gather baseline data
- Step 2: Prioritization and selection of next modality
- Step 3: Identification of significant environmental aspect(s) for the selected modality
- Step 4: Derive environmental targets and objectives for the selected modality
- Step 5: Implementation into company processes
- Step 6: Monitoring and reporting

and for the selection of the information to be assessed.

This responsibility includes the selection and application of appropriate methods to prepare the SRI Status Report as well as the use of assumptions and estimates for individual SRI disclosures which are reasonable in the circumstances. Furthermore, the responsibility includes designing, implementing and maintaining systems and processes relevant for the preparation of the SRI Status Report, which is free of material misstatements due to intentional or unintentional errors.

Audit Firm's Independence and Quality Control

We have complied with the German professional provisions regarding independence as well as other ethical requirements.

The audit firm applies the national legal requirements and professional standards – in particular the Professional Code for German Public Auditors and German Chartered Auditors ("Berufssatzung für Wirtschaftsprüfer und vereidigte Buchprüfer": "BS WP/vBP") as well as the joint opinion of the Wirtschaftsprüferkammer (Chamber of German Public Auditors; WPK) and the Institut der Wirtschaftsprüfer (Institute of Public Auditors in Germany; IDW): Requirements to quality control for audit firms ("Gemeinsamen Stellungnahme der WPK und des IDW: Anforderungen an die Qualitätssicherung in der Wirtschaftsprüferpraxis": "VO 1/2006") – and accordingly maintains a comprehensive system of quality control including documented policies and procedures regarding compliance with ethical requirements, professional standards and applicable legal and regulatory requirements.

Practitioner's Responsibility

Our responsibility is to express a limited assurance conclusion on the data marked with ✓ in the SRI Status Report based on our work performed.

Within the scope of our engagement we did not perform a substantive audit on external sources of information or expert opinions, used to prepare and referred to in the SRI Status Report.

We conducted our work in accordance with the International Standard on Assurance Engagements (ISAE) 3000 (Revised): “Assurance Engagements other than Audits or Reviews of Historical Financial Information” published by IAASB. This Standard requires that we plan and perform the assurance engagement to obtain limited assurance whether any matters have come to our attention that cause us to believe that the data marked with ✓ in the SRI Status Report has not been prepared, in all material respects, in accordance with the SRI six step methodology.

In a limited assurance engagement the evidence-gathering procedures are more limited than for a reasonable assurance engagement and therefore significantly less assurance is obtained than in a reasonable assurance engagement. The procedures selected depend on the practitioner's judgement. This includes the assessment of the risks of material misstatements of the data marked with ✓ in the SRI Status Report with regard to the above mentioned SRI six step methodology.

Within the scope of our work we performed amongst others the following procedures:

- Inquiries of personnel at the SRI Steering Committee Secretariat (COCIR) responsible for the preparation of the SRI Status Report regarding the process to prepare the report and the underlying internal control system;
- Inspection and sample testing of the systems and process documentation for collection, analysis and aggregation of the selected data;
- Recalculation of the aggregation and KPIs calculation for selected data;
- Analytical procedures on selected data;
- Inspection of documents regarding the description of the SRI six step methodology (SRI V3) and its application to MRI as detailed in ‘Magnetic resonance Equipment (MRI) - Study on the potential for environmental improvement by the aspect of energy efficiency’ and ‘Magnetic Resonance – Measurement of energy consumption’.

Conclusion

Based on our limited assurance engagement, nothing has come to our attention that causes us to believe that the data marked with ✓ in the SRI Status Report of the SRI for Medical Imaging Equipment under the Ecodesign Directive for the year 2015 has not been prepared, in all material respects, in accordance with the SRI six step methodology.

Emphasis of Matter – Recommendations

Without qualifying our conclusion above, we make the following recommendations for the further development of the reporting of the Self-Regulatory Initiative for Medical Imaging Equipment under the Ecodesign Directive:

- Develop a policy to require the SRI members to submit assurance certificates for annual sales data and data on the environmental aspects in scope for each modality;
- Further improvement of effectiveness and documentation of controls.

Restriction on Use and Distribution

We issue this report on the basis of the engagement agreed with COCIR. The review has been performed for purposes of the SRI for Medical Imaging Equipment under the Ecodesign Directive

and is solely intended to inform SRI for Medical Imaging Equipment under the Ecodesign Directive about the results of the review. The report is not intended for any third parties to base any (financial) decision thereon. We do not assume any responsibility towards third parties.

Munich, 8 September 2016

PricewaterhouseCoopers
Aktiengesellschaft
Wirtschaftsprüfungsgesellschaft



Hendrik Fink
Wirtschaftsprüfer
(German Public Auditor)



ppa. Dr. Patrick Albrecht

Appendix

Index to appendices**Page**

I Self-Regulatory Initiative („SRI“) Status Report 2015..... 1

General Engagement Terms for Wirtschaftsprüfer and Wirtschaftsprüfungsgesellschaften
[German Public Auditors and Public Audit Firms] as of January 1, 2002



Sustainable Competence
in Advancing Healthcare



SELF-REGULATORY INITIATIVE FOR MEDICAL IMAGING EQUIPMENT STATUS REPORT 2015



JULY 2016



REPORT OVERVIEW

The Status Report on the Self-Regulatory Initiative for medical imaging devices, published annually by the SRI Steering Committee presents information on the SRI, the developments and concepts, and the results achieved by participating companies.

This SRI Status Report 2015 consists of four main parts and eight appendixes

Part 1 offers a general introduction to the self-regulatory initiative, describing the development of the methodology from the first proposal in 2009 (SRIV1), to the second version (SRIV2) submitted to the European Commission and the Consultation Forum early in 2012 and the present third version (SRIV3).

Part 2 lists news and results of the work of the Steering Committee and the Expert Groups in 2013.

Part 3 explains in brief the content of the six steps of the SRIV2 methodology. More details on the methodology are available in the SRIV2 documentation (www.cocir.org).

Part 4 shows the results achieved in 2015 by participating companies for all the modalities under scope so far: ultrasound and magnetic resonance and the ecodesign goals for computed tomography, X-ray and nuclear imaging.

Appendix I summarizes the ultrasound pilot project and briefly present the SRI V1 methodology.

Appendix II displays the results of the SRIV2 methodology applied in 2010 to all the modalities in scope of the Self-Regulatory Initiative. Step 1 and step 2 of the methodology allowed to define a Priority List based on LCA data provided by companies.

Appendix III presents the results of the application of the methodology to magnetic resonance imaging equipment that have been identified as priority one for their environmental impact. The "MRI measurement of the energy consumption" methodology is also briefly introduced.

Appendix IV summarizes the findings of the 2013 project on computed tomography equipment and the application of the SRIV3 methodology.

Appendix V presents the findings of the application of the methodology to X-ray medical equipment.

Appendix VI introduces the nuclear imaging modality, the findings and the decisions of the SRI Steering Committee.

Appendix VII presents the new concept methodology to measure the circularity of the economy of the Medical Imaging Devices Sector. This new project has been launched as the SRI Steering Committee realized that contributing to circular economy can deliver more environmental benefits than improving energy efficiency only.

Appendix VIII shows the SRI list of relevant information that an Environmental Products Declarations (EPD) should contain.

Data and figures marked with the ✓ (green) logo have been in the scope of the PwC review 2015 (see page 78 for additional information).

Data and figures marked with the ✓ (black) logo were in the scope of previous PwC reviews (2010, 2011, 2012, 2013 and 2014)



TABLE OF CONTENTS

GENERAL INFORMATION ABOUT COCIR..... 4

PARTICIPATING COMPANIES 5

1. GENERAL INTRODUCTION TO THE SRI FOR MEDICAL IMAGING EQUIPMENT..... 6

 1.1. SELF-REGULATORY INITIATIVE V1 - 2009 6

 1.2. SELF-REGULATORY INITIATIVE V2 - 2012..... 6

 1.3. SELF REGULATORY INITIATIVE V3 - 2013 6

2. NEWS AND DEVELOPMENTS 2015 7

 2.1. 5TH ANNUAL FORUM MEETING ON 11 APRIL 2016 7

 2.2. LESSONS LEARNED FROM THE MRI PROJECT 7

3. THE SRI METHODOLOGY 8

 3.1. SCOPE..... 8

 3.2. STEP 1: GATHER BASELINE DATA 8

 3.3. STEP 2: PRIORITIZATION AND SELECTION OF NEXT MODALITY 8

 3.4. STEP 3: IDENTIFICATION OF SIGNIFICANT ENVIRONMENTAL ASPECT(S) FOR THE SELECTED MODALITY 9

 3.5. STEP 4: DERIVE ENVIRONMENTAL TARGETS AND OBJECTIVES FOR THE SELECTED MODALITY 9

 3.6. STEP 5: IMPLEMENTATION INTO COMPANY PROCESSES 9

 3.7. STEP 6: MONITORING AND REPORTING..... 9

4. ACHIEVEMENTS AND DEVELOPMENTS PER YEAR 10

 2011 - 10

 4.1. MAGNETIC RESONANCE 10

 2012 - 10

 4.2. COMPUTED TOMOGRAPHY 10

 4.3. CONCLUSION OF THE ULTRASOUND PILOT PROJECT 11

 2013 - 14

 4.4. X-RAY..... 14

 2014 - 15

 4.5. REVISION OF THE ULTRASOUND METHODOLOGY 15

 4.6. COCIR "GUIDELINES FOR MRI USERS ON SAVING ENERGY" 16

 4.7. NUCLEAR MEDICAL IMAGING 17

 2015 - 18

 4.8. MAGNETIC RESONANCE ACHIEVEMENTS 18

 2016 - 19

 4.9. CONCEPT METHODOLOGY TO MEASURE CIRCULAR ECONOMY 19

APPENDIX I 20

1. SRI GENERIC METHODOLOGY 20

 1.1. GATHER BASELINE DATA FOR ALL MODALITIES IN SCOPE (STEP 1) 20

 1.2. PRIORITIZATION AND SELECTION OF THE NEXT MODALITY (STEP 2)..... 20

 1.3. IDENTIFICATION OF SIGNIFICANT ENVIRONMENTAL ASPECT (STEP 3) 21

APPENDIX II 22

2. ULTRASOUND IMAGING EQUIPMENT 22

 2.1. MEASUREMENT OF THE ENERGY CONSUMPTION: 2015 22

 2.2. ULTRASOUND IMAGING EQUIPMENT PILOT PROJECT (2009/2012): CONCLUDED 23

 2.3. GENERAL DESCRIPTION OF ULTRASOUND EQUIPMENT..... 23

 2.4. MARKET COVERAGE..... 24

 2.5. SRIv1 METHODOLOGY FOR ULTRASOUND..... 24

 2.6. TARGET SETTING 24

APPENDIX III 25

3. MAGNETIC RESONANCE IMAGING EQUIPMENT 25

 3.1. GENERAL DESCRIPTION OF MAGNETIC RESONANCE EQUIPMENT..... 25

 3.2. MODES 26

 3.3. POWER CONSUMPTION 27

 3.4. MARKET DATA..... 28

 3.5. IDENTIFICATION OF THE MOST SIGNIFICANT ENVIRONMENTAL ASPECT FOR MRI..... 28



3.6.	COMPLEMENTARY DOCUMENTATION	29
3.7.	MEASUREMENT OF THE ENERGY CONSUMPTION	29
3.8.	ECODESIGN TARGET FOR MRI	34
3.9.	RELATIONSHIP BETWEEN SCAN AND READY-TO-SCAN KWH	41
APPENDIX IV		42
4.	COMPUTED TOMOGRAPHY	42
4.1.	GENERAL DESCRIPTION OF COMPUTED TOMOGRAPHY	42
4.2.	MARKET DATA	43
4.3.	IDENTIFICATION OF THE MOST SIGNIFICANT ENVIRONMENTAL ASPECT FOR CT	43
4.4.	MODES	44
4.5.	MODULARIZATION	45
4.6.	MEASUREMENT OF ENERGY CONSUMPTION	46
4.7.	ENERGY CONSUMPTION	48
4.8.	REDUCTION OF X-RAY DOSE – COCIR VOLUNTARY COMMITMENT WITH HERCA	49
4.9.	USER BEHAVIOUR.....	50
4.10.	IMPROVEMENT POTENTIAL	51
4.11.	APPLICATION OF SRIV3 METHODOLOGY TO CT.....	52
APPENDIX V		55
5.	X-RAY IMAGING EQUIPMENT	55
5.1.	GENERAL DESCRIPTION OF X-RAY IMAGING EQUIPMENT	55
5.2.	MARKET DATA	57
5.3.	MEASUREMENT METHODOLOGY	57
5.4.	THE MEASUREMENT METHODOLOGY IN BRIEF	57
5.5.	MODULARIZATION	59
5.6.	ENERGY CONSUMPTION	59
5.7.	IMPROVEMENT POTENTIAL	59
5.8.	USER BEHAVIOR.....	60
5.9.	INFLUENCING USER BEHAVIOUR	61
APPENDIX VI		62
6.	NUCLEAR IMAGING	62
6.1.	GENERAL DESCRIPTION OF NUCLEAR IMAGING EQUIPMENT	62
6.2.	MARKET DATA	63
6.3.	FUNCTIONING MODES.....	63
6.4.	ENERGY CONSUMPTION	64
6.5.	PET: POWER USAGE AND DAILY ENERGY CONSUMPTION	64
6.6.	SPECT: POWER USAGE AND DAILY ENERGY CONSUMPTION	64
65		
APPENDIX VII		66
7.	METHODOLOGY FOR ASSESSING THE CIRCULARITY OF THE MEDICAL IMAGING DEVICES BUSINESS MODEL	66
7.1.	BENEFITS OF REFURBISHMENT	66
7.2.	FROM LINEAR TO CIRCULAR: ROLE OF REFURBISHMENT	66
7.3.	RESOURCE EFFICIENCY OF ECONOMY MODELS	70
7.4.	MEASURING THE MEDICAL IMAGING SECTOR.....	73
7.5.	DEVELOPMENT OF THE METHODOLOGY	74
APPENDIX VIII		76
7.	EPD - ENVIRONMENTAL PRODUCT DECLARATION	76
APPENDIX VIII		78
8.	INDEPENDENT PRACTITIONER’S LIMITED ASSURANCE REPORT	78



GENERAL INFORMATION ABOUT COCIR

Founded as a non-profit trade association in 1959, COCIR¹ represents the Radiological, Electromedical and Healthcare IT industry in Europe. As such, COCIR members play a driving role in developing the future of healthcare both in Europe and worldwide. COCIR is committed to support its members and communicate with its partners in Europe and beyond on issues which affect the medical technology sector and the health of EU citizens. COCIR also works with various organisations promoting harmonised international standards and regulatory control that respects the quality and effectiveness of medical equipment and healthcare IT systems without compromising the safety of patients and users. COCIR encourages the use of advanced technology to support healthcare delivery worldwide. Key objectives are to include and to promote free worldwide trade of medical equipment and to maintain the competitiveness of the European health sector.

COCIR ENVIRONMENTAL HEALTH AND SAFETY COMMITTEE (EHS)

Founded in 2000 the COCIR EHS has taken several initiatives in the environmental domain introducing ecodesign initiatives in different ways:

- **2002 - 2007**, in the field of **International Standardisation**: COCIR member companies contributed to the development of an internationally-recognized standard integrating ecodesign into the product design and development process for all electromedical equipment. International Electro-technical Commission (IEC) published the International Standard IEC 60601-1-9
- In **2006**, in the field of **Integrated Product Policy**, as advocated by the EU's Action Plan on Sustainable Consumption and Production and Sustainable Industrial Policy (SCP/SIP)², COCIR member companies participated in an Integrated Product Policy project with the Hamburg authorities and hospitals.
- Keeping up with the latest inventions in medical technology often involves replacing equipment in medical practice before it reaches the end of its useful life. COCIR published in **2007** a version 1 of **Good Refurbishment Process (GRP)** describing in 5 steps how manufacturers can effectively refurbish equipment to ensure quality, safety and effectiveness of medical imaging equipment.
- COCIR published in **2008** a **guide** on REACH requirements for component suppliers and equipment manufacturers
- In **2008**, COCIR launched a **web-based database for substances declarations under REACH, RoHS, Batteries and Packaging directives called BOMcheck**. This centralized open-access database provides a cost-effective approach for manufacturers to work with their suppliers to reduce hazardous substances in products.
- In 2014, considering the importance of environment as a horizontal issue, the scope of the Committee was broadened, and now covers also health and safety.

COCIR.org

More detailed information on COCIR initiative in environmental domain could be found on COCIR website www.cocir.org.

¹ For more information: www.cocir.org.

² See COM(2008) 397, Brussels, 16.7.2008.



PARTICIPATING COMPANIES

The following companies participate in the SRI for Medical Imaging Equipment for the modalities they market in EU.

Table 1: Participating companies in 2015

	Magnetic Resonance MRI	Computed Tomography CT	Nuclear Medicine NM	Radiology X-RAY	Ultrasound US	Radiation Therapy ³ RT
Elekta						☒
Fujifilm				☒		
GE Healthcare	☒	☒	☒	☒	☒	
Hitachi Medical Systems Europe	☒	☒			☒	
IBA - Ion Beam Applications						☒
Philips Healthcare	☒	☒	☒	☒	☒	
Samsung Europe					☒	
Siemens Healthcare	☒	☒	☒	☒	☒	
Toshiba Medical Systems Europe	☒	☒		☒	☒	
Agfa Healthcare ⁴				☒		

³ Radiation Therapy (RT) has been added this year to the table as the new "circular economy" project (see Appendix 7) covers all modalities. Elekta and IBA have been moved to RT as this better represent their activities

⁴ Agfa Healthcare joined the SRI in 2015 following the decision to investigate "circular economy"



1. GENERAL INTRODUCTION TO THE SRI FOR MEDICAL IMAGING EQUIPMENT

The Energy Related Products (Ecodesign) Directive, 2009/125/EC, enables the European Commission (EC) to set ecodesign requirements through new regulations for any group of products which uses energy.

In 2007, Medical Devices were identified as a "Priority A" product group by the EC for future regulation. To avoid adverse business impacts (unnecessary costs and loss of flexibility in product design), COCIR reached a consensus with the EC to develop an alternative approach allowed under the Ecodesign Directive Annex VIII (Self-Regulatory Initiative for an industry sector).

1.1. SELF-REGULATORY INITIATIVE V1 - 2009

During the EC Consultation Forum⁵ meeting on **28 May 2008** COCIR presented its first proposal for an industry-led Self-Regulatory Initiative. The EC welcomed this alternative approach as it could achieve the same overall objective as an implementing regulation but would avoid potential negative business impact. In particular, the EC emphasised that "*regulation would risk hampering innovation in the medical equipment sector, where technology evolves rapidly*".

Based on this positive feedback, COCIR decided in **September 2008** to establish the SRI Steering Committee (*hereafter: SRI SC*) in order to further develop this Initiative and develop the methodology.

- In **May 2009** the developed methodology (*hereafter: SRI*) was applied to ultrasound products in a pilot project to gather experience from practical implementation.
- In **November 2009** the methodology and the pilot project on ultrasound products was presented to the Consultation Forum. Comments were gathered for further improvements.
- In **2010** COCIR and the Steering Committee worked on the SRI v1 to update and improve it taking into account the comments received from the Members of the Consultation Forum, the EC and the lessons learnt from the ultrasound pilot project.

1.2. SELF-REGULATORY INITIATIVE V2 - 2012

The result of the thorough analysis and review is the SRIv2 6 step methodology which the Steering Committee considers to address all concerns.

The SRI has been submitted to the European Commission and Consultation Forum in January 2012 and the Consultation phase closed on 5th March 2012. The SRI has been officially acknowledged by the Commission in November 2012.

1.3. SELF REGULATORY INITIATIVE V3 - 2013

In 2013 the SRI Steering Committee reviewed the SRIv2 Methodology to integrate received comments and the new findings and methodologies developed during the MRI project in 2012. The methodological aspects have been separated from the commitments of signatories. Two papers are now available for download on the COCIR website:

1. COCIR Self-Regulatory Initiative
2. COCIR Self-Regulatory Initiative Methodology V3 (SRIv3)

⁵ Article 18 of the Ecodesign Directive (2009/125/EC) establishes a "Consultation Forum" (CF) which allows stakeholders to be informed and consulted on the implementation of the Directive. The Forum is limited to 60 members, including representatives of EU Member State, 3 representatives of EEA Member States, 30 stakeholders (Stakeholders have been selected by the EC following an open call for interest).



2. NEWS AND DEVELOPMENTS 2015

During 2015 the Steering Committee worked on a concept methodology to measure the circularity of the medical imaging business model in EU. Having a methodology is the first step for monitor environmental aspects and defining an improvement goal. The initial proposal is reported in Appendix VII.

2.1. 5TH ANNUAL FORUM MEETING ON 11 APRIL 2016

During the 5th Annual Forum of the COCIR SRI on 12 April 2016, the SRI Steering Committee presented the results of the work performed in 2015.

In particular the discussion focused on the package adopted by the EC on Circular Economy and how such concept can be introduced in the SRI methodology. The initial methodology presented during the meeting is now included in this report in Appendix VII.

The event was open to Members of the Consultation Forum, Stakeholders and Interested Parties. The documents presented and discussed during the meeting are now available at the COCIR website.

2.2. LESSONS LEARNED FROM THE MRI PROJECT

In 2014 a SRI Member achieved a substantial decrease in market average by improving the software architecture and the cryo-cooling system of MRIs. In particular improvement of the cryo-cooling system was not in the list of the "possible" improvements identified during the evaluation of improvement potential (COCIR: [Magnetic Resonance Equipment \(MRI\) - Study on the potential for environmental improvement by the aspect of energy efficiency, page 22](#) – available at COCIR website).

In 2015 a different company obtained a significant reduction by implementing a technical improvement that again was not identified during the study on improvements potential.

This experience shows that it is very difficult to identify, at the beginning of an eco-design process, all the possible improvements of a complex technology, and that new improvement solutions are discovered as the eco-design process continues. Having an eco-design process in place is the best way to ensure that new solutions are identified.



3. THE SRI METHODOLOGY

The SRI methodology is the process participating companies shall follow to set ecodesign targets for their products and ensure that they are achieved.

The purpose of the SRI methodology is to:

- Provide a transparent and continuous process to control the application of ecodesign targets while protecting company confidential information.
- Set a priority sequence for the equipment evaluation.
- Identify top environmental aspects.
- Set environmental targets.
- Systematically engage stakeholders.
- Monitor and report progress.

The SRI methodology is based on six key steps. The iterative process allows the member companies to offer their confidential internal life cycle assessment data for each modality, life cycle stage and aspect selection processes. This provides a comprehensive analysis which any one single approach could not achieve.

3.1. SCOPE

The SRI methodology applies to the following imaging equipment:

- Magnetic Resonance Imaging equipment (MRI)
- Computed Tomography (CT)
- Nuclear Medicine (NM)
- X-ray
- Ultrasound (US)
- Therapy equipment (second cycle)

Every year at least one new modality is selected until all modalities in scope have been chosen.

After a modality has been selected (via the priority list resulting from Step 1 and 2), it will remain in the continuous improvement circle (Steps 3 to 6). This means that once a modality has been selected and the industry has achieved the target to minimize the aspect with the highest environmental impact and potential for improvement, another assessment of the most significant aspects will be done.

3.2. STEP 1: GATHER BASELINE DATA

The purpose of the first step is to establish a baseline for prioritization and improvement. The method of the first step is to collect Member Company Life Cycle Assessment (LCA) data on products in scope of the SRI.

The provided information in Step 1 contains typical LCA data per modality and company, including the defined use scenarios, functional units, impact categories and intended use, the percentage of life cycle contribution, the individual environmental load per modality related to the corresponding LCA method, as well as a plausibility check based on expert expectations on the future capacity for innovation of the modality.

3.3. STEP 2: PRIORITIZATION AND SELECTION OF NEXT MODALITY

The purpose of the second step is to analyse the baseline data in order to prioritize the modalities for evaluation. The method of the second step is to rank the environmental load and other data from each modality.



3.4. STEP 3: IDENTIFICATION OF SIGNIFICANT ENVIRONMENTAL ASPECT(S) FOR THE SELECTED MODALITY

The purpose of the third step is to analyse and prioritize the three most significant environmental aspects contributing to the total environmental impact of the selected modality. The method of the third step is to rank the data on the top three environmental aspects, including the percentage of their contribution to the total life cycle.

3.5. STEP 4: DERIVE ENVIRONMENTAL TARGETS AND OBJECTIVES FOR THE SELECTED MODALITY

The purpose of the fourth step is to develop ecodesign targets. First the selected modality is defined (system boundaries, categories, parameters, protocols, use scenarios, etc.) and then a measurement methodology for the chosen environmental aspect (e.g. energy consumption) is developed. The methodology allows companies to measure their equipment.

The SC Secretariat uses the above mentioned collected values and the results of the study on improvement potential (when appropriate) to calculate the target scenarios:

- Best available technology as Baseline (BAT)
- Business as usual (BAU)
- Best not yet available technology (BnyAT)
- Beyond Business as usual (Beyond BAU)

Based on these scenarios, the SRI SC decides on a feasible industry reduction target. Before it is integrated into the companies' design targets, the industry target is proposed to the European Commission for discussion.

The results of this step are two types of targets:

- **Individual company targets:** These are absolute improvement targets which are calculated on the basis of declared values and expected sales at the end of the innovation cycle. Company targets are communicated by the SRI SC Secretariat to each company in a confidential way. It remains at the company's own discretion to publish this individual target.
- **Industry target:** This target represents the market fleet average the Industry is committed to achieve in a period of time equal to the innovation cycle.

3.6. STEP 5: IMPLEMENTATION INTO COMPANY PROCESSES

The purpose of the fifth step is the integration of the ecodesign target(s) into the internal company processes. The translation of the target(s) into the company internal product design process remains up to the individual member.

3.7. STEP 6: MONITORING AND REPORTING

The purpose of the sixth step is to monitor and report on the achievement of the industry target. The method of the sixth step is to calculate the averages of the annually reported impact values and comparison to the Baseline. The status of each modality and the progress that the companies are making is annually reported to the Stakeholders with this SRI Status Report.



4. ACHIEVEMENTS AND DEVELOPMENTS PER YEAR

2011 -

4.1. MAGNETIC RESONANCE

In 2011 the SRI Steering Committee officially launched the eco-design target for MRI after the finalization of:

- The MRI energy consumption measurement methodology
- The study on improvement potential
- The ecodesign target for 2017
- The data collection for 2010 and 2011

2012 -

4.2. COMPUTED TOMOGRAPHY

The SRI SC applied the SRI v3 methodology to Computed Tomography, studying the potential for improvements of the technology, defining a measurement methodology for energy consumption and defining an eco-design goal to develop initiatives with the aim to educate users on how to operate the CT scanners in an environmental friendly way.

4.2.1. INFORMATION TO USERS – ENERGY INFORMATION

The CT energy measurement procedure provides for manufacturers to report the energy consumption of CT systems in the following scenarios:

Scenario-Off: This value represents the daily energy consumption when the CT scanner is switched off during the 12h night time (no energy consumption).

Scenario-LowPower: This value represents the daily energy consumption when the CT scanner is switched to LowPower during the 12h night time.

Scenario-Idle: This value represents the daily energy consumption of the CT when it is left in idle mode for 12h during night time.

Those three values could prove very useful to the user as they underline the difference in energy consumption that can be achieved according to the way the CT scanner is used. They also provide to the user or the purchaser a clear indication on the running cost and how much energy and money can be saved by a correct utilization of the CT.

The following data format has been developed and is recommended for use in product documentation when presenting energy consumption data measured according to the COCIR SRI CT Measurement Methodology. Data should be expressed to the nearest 1 kWh.



Typical Energy Consumption			
The typical energy consumption values have been measured according to the COCIR <i>Self-Regulatory Initiative CT Measurement of Energy Consumption</i> , version 1.0			
Model:			
Use Case Scenario*	Energy per Day (exemplary values)	Units	Deviation, Justification
Scenario-Idle	72	kWh	
Scenario-LowPower	50	kWh	
Scenario-Off	37	kWh	

* The system use scenario varies according to customer needs during overnight hours. According to the standard, the system is in active use for 12h during the day and inactive for 12h overnight. The 12h overnight may be in Idle, LowPower, or Off modes with corresponding daily energy consumption variations.
 Measured values in this table are to be used for economic estimation purposes only. These values do not imply, and are not to be used for, conformance to any clinical or safety requirements.

Additional scenarios can be added by Companies for specific power modes and specific functionalities as long as such scenarios are measured according the COCIR CT Measurement Methodology for LowPower mode.

4.3. CONCLUSION OF THE ULTRASOUND PILOT PROJECT

The Ultrasound pilot project concluded in 2012 as scheduled but the monitoring continued in 2013 as well. As shown in the figure, in 2012 the annual average energy consumption per unit for ultrasound equipment reached 743 kWh/unit against a set target of 691 kWh/unit. A reduction of around 20% in the average annual consumption per model had been achieved compared to the 2005 baseline. In 2013 the average energy consumption per unit decreased significantly to 643 kWh/unit going beyond the set target.

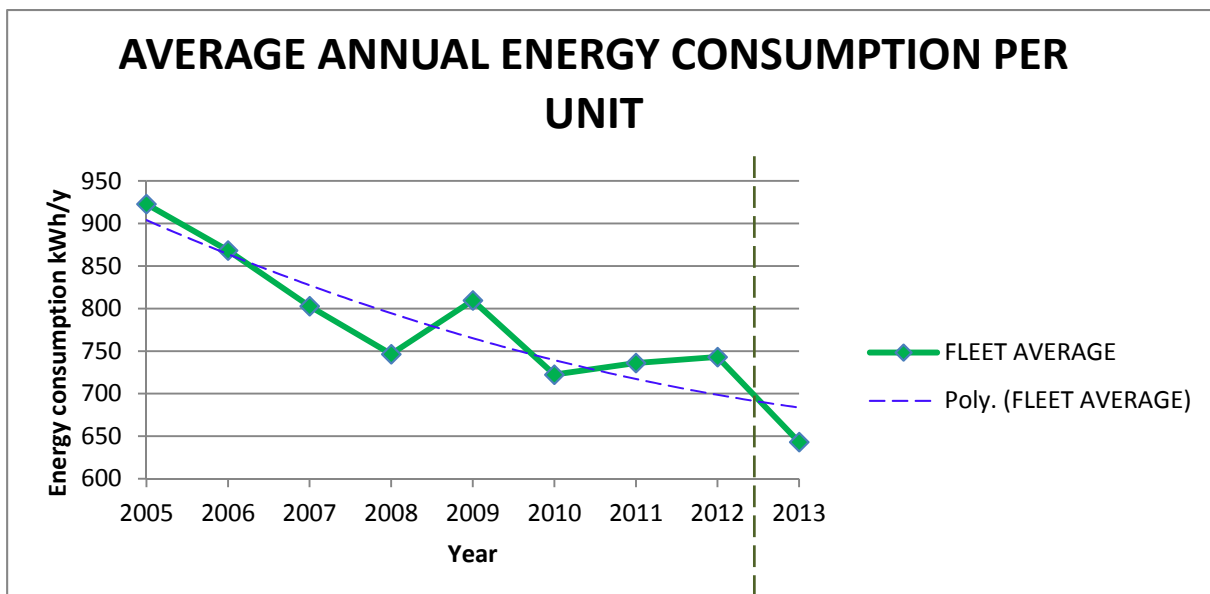

Figure: Ultrasound annual energy consumption per unit: market fleet average

More information on the pilot project are reported in Appendix II.



4.3.1. INTERPRETATION OF DATA (2005/2013)

The analysis of the data shows and confirms the following conclusions:

1. At least two categories of U/S equipment could be identified with very different behaviour. Low energy using U/S (handheld and laptop based) and high energy using U/S (large self-standing hospital equipment). See figure 1 and figure 2.
2. Each category displays a decreasing trend of the annual average energy consumption per unit.

4.3.2. LOW AND HIGH ENERGY USING US

Collected data confirms 2 categories with different behaviour can be defined for U/S equipment. This limit of the ultrasound project was already understood and reported previously and integrated in the SRIV2 and in the MRI project (where 3 categories have been identified).

1. Low energy using U/S: handheld and laptop based ultrasound equipment.
2. High energy using U/S: large self-standing hospital ultrasound equipment.

As figure 1 below shows, the two categories are subject to different dynamics in sales. High energy U/S sales decreased constantly between 2006 and 2010 when they started to increase again. During the same period the sales of low energy using US show an erratic behaviour.

In particular the increase of High U/S in 2012 together with the strong decrease in sales of Low US explains the increase in the average annual energy consumption per unit registered in 2009 and 2012. In 2011 sales of Low U/S increased less than the sales of High U/S therefore increasing the average energy per unit.

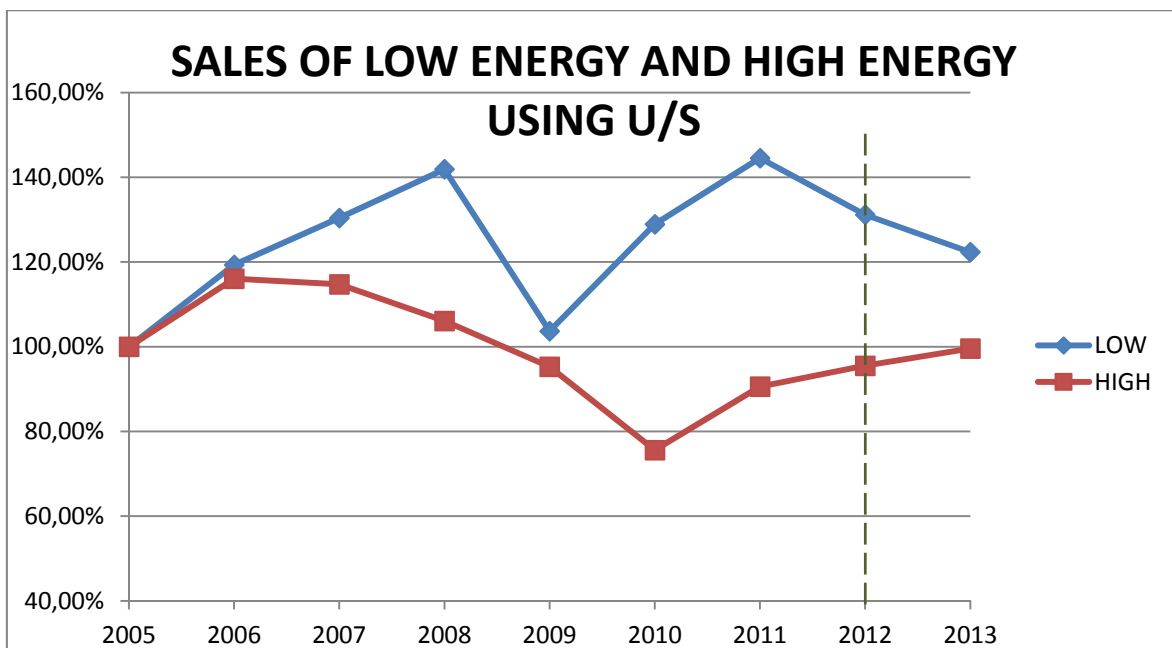

Figure 1: Sales of high energy using and low energy using ultrasound equipment compared to 2005 baseline



4.3.3. REDUCTION IN ENERGY CONSUMPTION DUE TO TECHNICAL IMPROVEMENTS

In the COCIR SRI both technical improvements and sales mix account for target achievement. While technical improvements can be controlled by companies, sales can be influenced but not controlled. As shown so far, market demand is hardly predictable and inconstant therefore it could play a critical role in target achievement (positive or negative).

Nonetheless the subdivision of U/S in two different categories allows analysing the energy behaviour of each category.

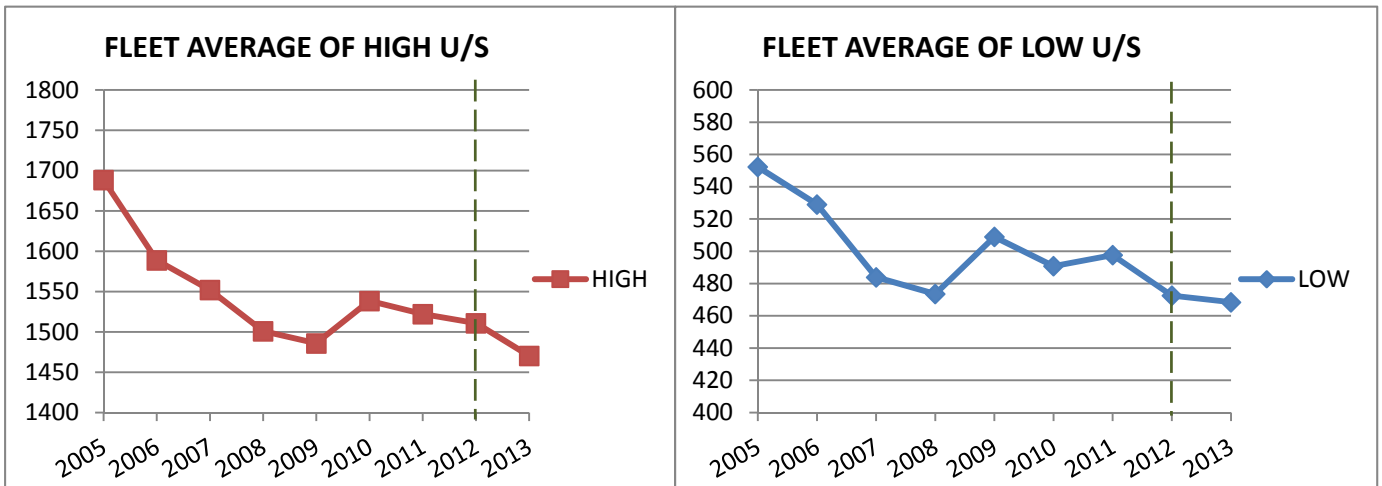

Figure 2: Fleet average for high and low energy consuming ultrasound products

As clearly shown in figure 2 the average energy consumption of both categories has been following a decreasing trend since 2005 (with some exception). In 2012, High U/S being a mature technology registered a reduction of ✓10,5% while Low U/S, a more recent technology, registered a reduction of ✓14,4%.



2013 -

4.4. X-RAY

The SRI SC studied the x-ray modality in 2013. Unlike other imaging equipment in the scope of the SRI there is a big number of companies manufacturing x-ray devices. The actual SRI participating companies cover around 92% of the market for angiography systems, but less than 52% for all the remaining categories.

X-ray devices are quite simple compared to the modalities analyzed so far by the SRI (MRI and CT) and the energy consumption is lower (See appendix V).

Considering the great variety of X-ray categories and different uses (from mobile c-arc to stationary interventional systems), it is impossible to identify a general user behaviour. Nonetheless considering the findings of previous projects it can be expected that most users do not profit of the low power or switch off functions of x-ray devices. This is supported by the study of the Danish Energy Saving Trust "Energy Efficiency in Hospitals and Laboratories ", where the energy consumption of x-ray and user behavior have been investigated.

Already existing Off and LowPower modes, if used properly by users could ensure an energy saving between 50,5% and 64,3% of daily energy consumption (see Appendix V). Nonetheless such options are not widely used by users. The use of Off mode during the night hours and weekend can save on average up to 3,45 MWh per year per equipment.

The COCIR SRI has set an industry goal to develop initiatives with the aim to educate users on how to operate the X-ray scanners in an environmental friendly way.

4.4.1. COCIR "GUIDELINES FOR X-RAY USERS ON SAVING ENERGY"

The development of information material to be disseminated to users can play a significant role in changing user perception and therefore in influencing behaviours. Given the importance of potential savings in the use of x-ray equipment, the SRI SC Committee started the development of a new brochure for X-ray in the course of 2014 which has been disseminated to users and purchasers.

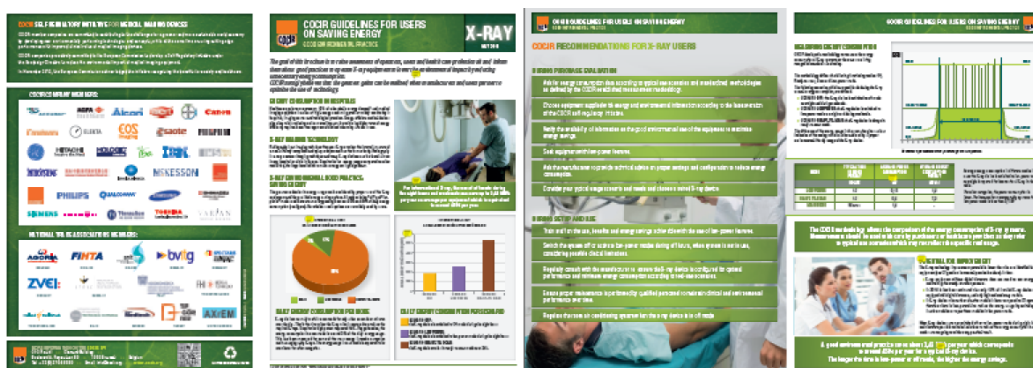

COCIR draft brochure: "COCIR X-ray Guidelines for Users on Saving Energy - Good Environmental Practice"



4.4.2. COCIR “GUIDELINES FOR CT USERS ON SAVING ENERGY”

The development of information material to be disseminated to users can play a significant role in changing user perception and therefore in influencing behaviors. In 2013 COCIR developed the “COCIR Guidelines on energy saving on Computed Tomography – Contribution to healthcare environmental sustainability” which have been officially released in January 2014.

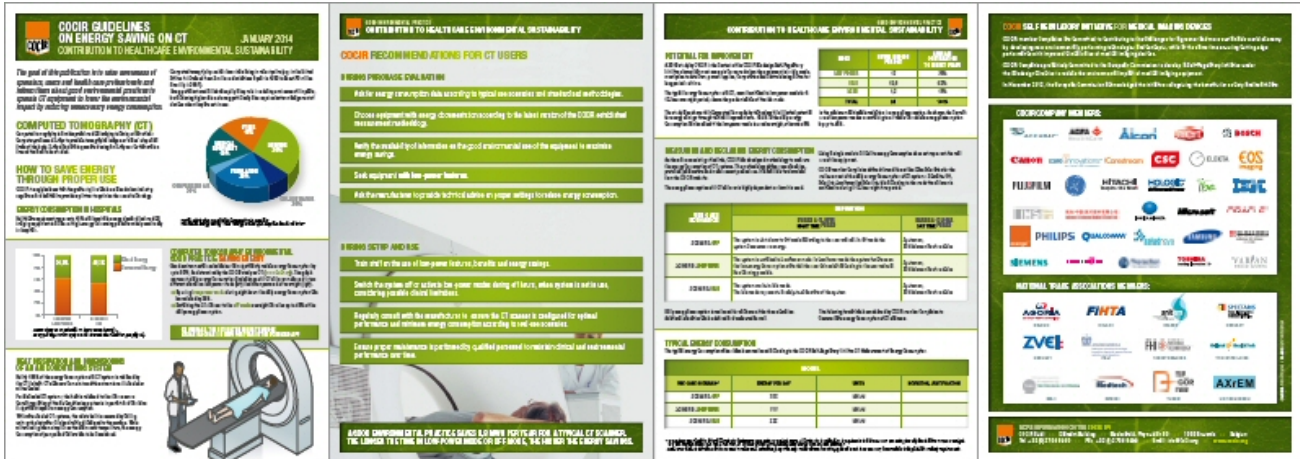

The objective of the Guidelines is not only to provide useful recommendations but also to provide figures on the possible savings achievable with a proper use. Such savings can be quantified for the first time thanks to the COCIR SRI methodology for energy measurement.

The brochure has been disseminated to users and patient organizations:

- European Society of Radiology (ESR): <http://www.myesr.org>
- European Patient Forum (EPF): <http://www.eu-patient.eu/>
- European Federation of Nurses Associations (EFN): <http://www.efn.be/>
- European Hospital and Healthcare Federation (HOPE): <http://www.hope.be/>
- Healthcare Without Harm (HCWH): <http://www.noharm.org/>
- Head of European Radiological protection Competent Authorities (HERCA): <http://www.herca.org>

The guidelines have been also distributed in paper version at the European Congress of Radiology (ECR), held in Vienna beginning of March 2014.

2014 -

4.5. REVISION OF THE ULTRASOUND METHODOLOGY

In 2009 the SRI Steering Committee set a target for the Ultrasound Pilot project to achieve by 2012 a 25% reduction in energy consumption compared to 2005, the year chosen as reference. The Pilot concluded in 2012 while the monitoring continued until 2014. The achievements of the pilot are reported in chapter 4.3.

In 2014 the SRI Steering Committee decided to focus again the attention on Ultrasound without waiting for 2016, as scheduled. The pilot methodology for the measurement of the energy consumption of ultrasound equipment was developed in 2009 and was not intended to produce data for comparing different product performances. With the incoming revision of the EU GPP criteria for medical devices, COCIR would like to see a better methodology included in the GPP criteria for U/S equipment.

Therefore, in 2015, the SRI SC released the new “[U/S measurement of energy consumption:](#)



[methodology](#)” paper which can be freely downloaded from the COCIR website. At the same time the monitoring of the Ultrasound energy consumption has to be halted. In fact, the new methodology is going to change the way U/S devices are measured and therefore the new figures will not be comparable with the old measurements.

The SRI SC discussed in 2015/2016 the feasibility of restarting the monitoring, in particular considering the time needed to companies to re-measure their equipment with the new methodology. In particular for old models this could be expensive and time consuming. The activity may be limited to newly released models. New environmental aspects such as use of resources may be evaluated as well considering the continuous reduction in size of U/S devices.

4.6. COCIR “GUIDELINES FOR MRI USERS ON SAVING ENERGY”

Following the findings of the CT project, COCIR realized that the user behaviour has an important influence on the energy consumption of MRI.

Scenarios have been defined:

- **Scenario-Off:** the MRI scanner is turned in Off6 mode during the 12h night time.
- **Scenario ready-to-scan:** the MRI is always in ready-to-scan mode.

Considering that during the weekend the scanner can be in Off mode or Ready-to-scan mode for 24 hours, the use of the Off mode allows for saving up to 21,8% of the annual energy consumption which on the average corresponds to 29,2 MWh/y.

The development of information material to be disseminated to users can play a significant role in changing user perception and therefore in influencing behaviors. Given the importance of potential savings, the SRI SC Committee developed a new brochure for MRI in the course of 2014 which has been disseminated to users and purchasers.

YEARLY ENERGY SAVINGS

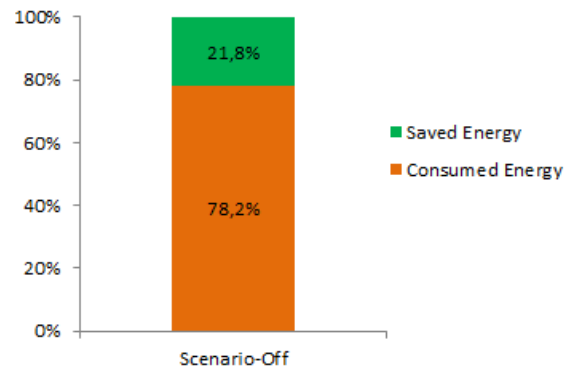

Figure 3: MRI energy savings by using Off-mode



COCIR brochure: “COCIR MRI Guidelines for Users on Saving Energy - Good Environmental Practice”

⁶ The MRI cryo-cooler cannot be stopped therefore there Off Mode has a significant energy consumption

4.7. NUCLEAR MEDICAL IMAGING

The COCIR SRI focuses on PET and SPECT nuclear imaging modalities. Combined technologies such as PET-CT, SPECT-CT, PET-MRI are not considered for the complexity of the technology, and the recent introduction on the market (2010 for the first installed PET-MRI).

The initial analysis of medical nuclear images shows that PET is not sold anymore as single technology but always in combination with CT or MRI, due to huge increment in clinical value of adding precision of anatomic localization to functional imaging.

SPECT is sold in small numbers (116 units in 2013) and presents very low energy consumption, comparable to X-ray systems. The comparison of the average energy consumption of SPECT (15 kWh/d) with other modalities such as MRI (250/300 kWh/d or CT 70kWh/d) makes clear the limited relevance of SPECT energy consumption.



For the above mentioned reasons, and considering that nuclear imaging is not included in the EU GPP criteria, the SRI SC decided not to proceed with the development of a measurement methodology for SPECT or PET but to give priority in 2014/2015 to the definition of the U/S measurement methodology, giving also the impending revision of the EU GPP criteria for EEE in the medical sector.

Considering the power usage stability of PET and SPECT in different modes, and the limited potential savings achievable by users the SRI SC did not deem necessary to develop a COCIR Guideline to energy saving for nuclear medicine at least for this year.

The COCIR SRI will discuss and evaluate the possibility to include combined technologies in the SRI.

2015 -

4.8. MAGNETIC RESONANCE ACHIEVEMENTS

The SRI Steering Committee calculated the average annual energy consumption for new products put on the market for the year 2015. The data is used to assess achievements compared to the baseline 2011 (see Appendix III for additional details on methodology and calculations).

As shown by table 3, in 2015 the daily average energy consumption per unit for MRI equipment decreased to ✓176,91 kWh/unit showing a 21% reduction compared to 2011 and a 5% compared to 2014.

Table 3⁷: Calculated values for year 2011-2015 and forecast until 2017 under the assumption of a linear trend

	Sold units ⁸	Total daily energy consumption (kWh) ⁹	Average daily energy consumption per unit (kWh/d)	Beyond BAU (kWh/d)	BAU (kWh/d)
2011	✓394	✓89.011	✓225,92		
2012	✓446	✓100.038	✓224,30	225,61	230,39
2013	✓454	✓95.148	✓209,58	225,30	234,87
2014	✓513	✓95.572	✓186,30	225,00	239,34
2015	✓604	✓106.855	✓176,91	224,69	243,81
2016				224,38	248,29
2017				224,07	252,76

The reduction compared with the BAU baseline implies that the SRI will save in 2017 around 7459¹⁰ kWh per unit sold according to the Beyond BAU scenario, equivalent to more than 2,6 tons of CO₂¹¹ per year per unit.

Interpretation of the data

The fleet average energy consumption continued the reduction trend in 2015. While fluctuations in the fleet average may be due to a different sales mix, the drop in 2015 is mostly due to the increased performance of participating companies, as shown by figure 2.1.

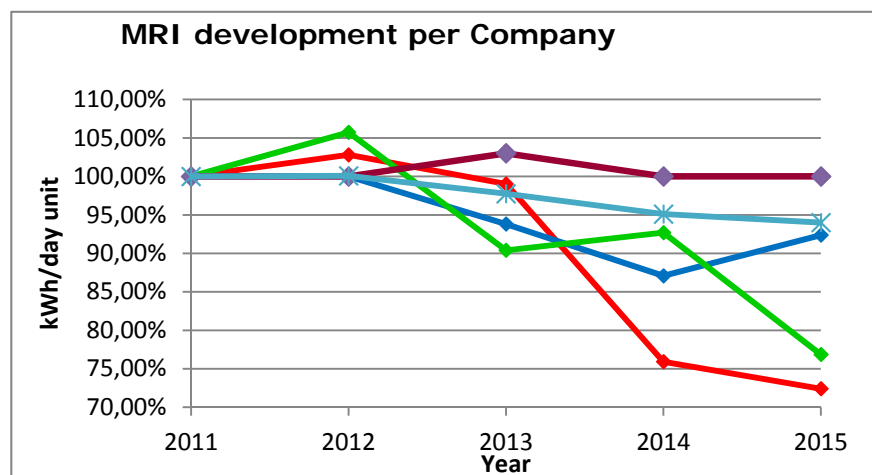

Figure 2.1: trend in company fleet average daily energy consumption per company

⁷ Values are slightly different from the ones in SRI Report 2012 due to a retrospective re-categorization of products by one company causing a variation of SRI sales and related energy consumption data of 0,15% in 2011 and 0,13% in 2012 compared to the values reported in previous SRI Status Reports

⁸ Sold units data provided by companies for each model placed on the market in the calendar year

⁹ Measured energy consumption data provided by companies for each model placed on the market in the calendar year.

¹⁰ Assuming 5 days per week, 52 weeks per year

¹¹ Conversion factor gCO₂/kWh = 350. Average value for Europe 28 in 2012. Source: CO₂ Emissions from Fuel Combustion (2014 Edition), IEA, Paris.



2016 -

4.9. CONCEPT METHODOLOGY TO MEASURE CIRCULAR ECONOMY

In 2016, at the 5th Annual Forum on the COCIR SRI, COCIR presented its conclusions about reuse and refurbishment activities being the most significant contribution to reducing environmental impact of medical imaging devices.

In 2015/2016 COCIR worked on a first methodology to estimate the circularity of the economic model.

The European Union is aiming at moving the current “linear” model towards a circular one by means of modification of current legislation and introduction of new one.

But moving from a linear model to a circular one is not a linear process. While it is clear that a perfect circular economy cannot be achieved, the degree of success depends on the implementation of all possible measures to prevent waste generation and use of resources from the design to the end of life phase, and to boost recycling of waste. The system complexity therefore increases linearly with the number of feedback loops which bring resources back to use diverting them from landfill, which is considered the end of the cycle.

From a linear economy model



*EOL: End of life phase

To a circular model

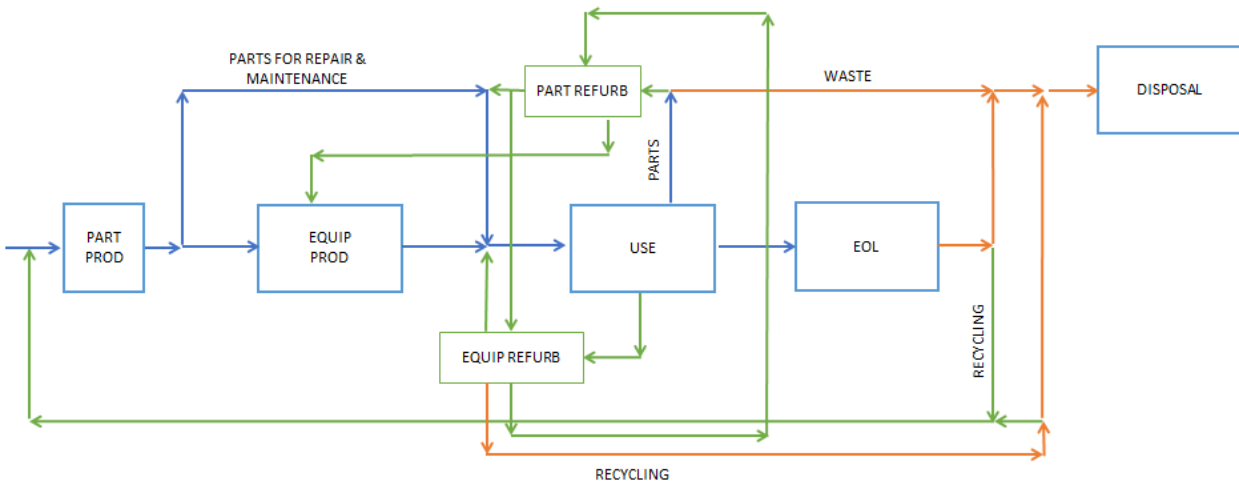

The methodology drafted in Appendix VII aims at defining an index which can be later used for monitoring improvements. Additional work is needed to shape the methodology in such a way that the calculation of the index is based on data which can be obtained by companies with good approximation.



APPENDIX I

1. SRI GENERIC METHODOLOGY

In 2010 the SRI Steering Committee started to apply the methodology first two steps to all the modalities in scope to identify a priority list.

1.1. GATHER BASELINE DATA FOR ALL MODALITIES IN SCOPE (STEP 1)

Baseline data was gathered according to a specific template (see SRI Methodology V3 Appendixes). According to the product portfolio of the SRI members (see table 1) data has been delivered from the following companies¹²:

- GE Healthcare
- Philips Healthcare
- Siemens Healthcare
- Toshiba Medical Systems Corporation

For the following modalities and sub-modalities:

- Computed tomography (CT)
- Magnetic Resonance Imaging (MRI)
- Nuclear Medicine
 - NM Conventional
 - NM PET
- X-Ray
 - X-Ray Angio
 - X-Ray Fluoro
 - X-Ray Radio
 - X-Ray Mammography
 - X-Ray Surgery

1.2. PRIORITIZATION AND SELECTION OF THE NEXT MODALITY (STEP 2)

The company LCA data from STEP 1 have been consolidated by the SC Secretariat after a plausibility check.

The SC Secretariat calculated two rankings with the provided LCA data:

- The first ranking weights the environmental loads (delivered by the companies in STEP 1) with current units sold in EU (based on SHARE¹³ data).
- The second ranking is based on the expert judgements on factors such as feasible technological developments and the complexity of the product, as well as on sales forecasts of the next generation equipment.

The final priority list, see table 5, that is used to select the next modalities is obtained averaging the two previously calculated rankings.

¹² Only already available LCA data has been provided. According to SRIv2 methodology Step 1 and 2 do not require LCA data to be provided by all the participating companies.

¹³ SHARE is COCIR's internal market statistics data base.

**Table 5:** Priority list

Modality	Environmental loads ranking 2009	Risk Assessment ranking 20xx*	Average Ranking	Final Ranking
MRI	1	1	1	1
CT	3	2	2,5	2
X-Ray	2	3	2,5	3
Nuclear Medicine	4	4	4	4

*depends on the typical modality innovation cycle

CT has been chosen as second one as the European market coverage of the participating companies is around 100%, while for X-ray it is about 80%. The higher the market coverage, the higher the reduction of environmental impacts that the SRI Initiative could achieve.

According to table 6, the SRI Initiative will focus on the listed modalities in the given sequence, at least one each year. Thus, MRI was targeted as the first modality under the SRI methodology and CT as second one.

Table 6: Timetable for targeting new modalities

	2011	2012	2013	2014	2015
MRI	☒				
CT		☒			
X-Ray			☒		
Nuclear Medicine				☒	
Ultrasound					☒

1.3. IDENTIFICATION OF SIGNIFICANT ENVIRONMENTAL ASPECT (STEP 3)

Every year a new part is added with a new modality, following the order of the priority list. Each new part for the specific modality includes data on the identification of the top environmental aspect.



APPENDIX II

2. ULTRASOUND IMAGING EQUIPMENT

2.1. MEASUREMENT OF THE ENERGY CONSUMPTION: 2015

In 2014 the SRI Steering Committee decided to focus again the attention on Ultrasound imaging equipment instead of waiting for 2016, as scheduled. The pilot methodology for the measurement of the energy consumption of ultrasound equipment was developed in 2009 and was not intended to produce data for comparing different product performances. COCIR developed a better methodology in particular for battery powered equipment.

2.1.1. SCOPE

The methodology is designed to work for all ultrasound equipment, given that the energy consumption in ready-to-scan mode and scan mode are virtually the same. Certain high-end models are able to perform real-time 3D imaging for some specific examinations (i.e. obstetric). In those particular examinations the power usage during scan can be 20% higher than the power in ready-to-scan modes. Considering the limited numbers of such equipment and of examinations, such models are not covered by this methodology. To measure the energy usage of such models, scan conditions and parameters should be defined to allow the measurement of the energy consumption.

2.1.2. THE METHODOLOGY IN BRIEF

The following functioning modes have been defined for ultrasound equipment:

Mode	Description
Off:	The system is shut down according to the user manual, plugged into mains, AC mains ON
Stand-by	The system is configured in the lowest possible energy consuming state, according to the user manual
Ready-to-scan	The system is fully powered and ready to acquire image
Scan	The system is acquiring image. This mode includes ultrasound generation and real-time image rendering

The power usage is measured in the different modes and the daily energy usage calculated according to 3 different scenarios.

Scenarios and distribution of time in functioning modes	Time in Off mode (h)	Time in Stand-by mode (h)	Time in Ready-to-scan mode (h)
Scenario Off	12	6	6
Scenario Stand-by	0	18	6
Scenario Ready-to-scan	0	0	24

The energy consumption expressed in different scenarios is useful as it allows the immediate comparison of the energy consumption related to different ways of using the equipment.

The monitoring of the Ultrasound energy consumption has to be halted concluding the Pilot Project. In fact the new methodology is going to change the way U/S devices are measured and therefore the new figures will not be comparable with the old measurements.

2.2. ULTRASOUND IMAGING EQUIPMENT PILOT PROJECT (2009/2012): CONCLUDED

When COCIR and the participating companies started to develop the Self-Regulatory Initiative, the methodology and approach was a new terrain for all. Participating companies initiated a first non-standardised review of the products in scope to establish the product of initial focus for a pilot, to develop the industry baseline for energy trending, and to establish targets and timing. The final choice of ultrasound imaging equipment was based on the following reasons:

- Ultrasound equipment is manufactured by the majority of the COCIR participating companies in the Self-Regulatory Initiative: Hitachi Medical Systems Europe (ex-Aloka)¹⁴, GE Healthcare, Hitachi Medical Systems Europe, Samsung (ex-Medison)¹⁵, Philips Healthcare, Siemens Healthcare and Toshiba medical Systems Europe. The inclusion of many manufacturers could steep the learning curve.
- COCIR members have a good understanding of environmental aspects and opportunities to reduce environmental impacts for ultrasound equipment. Most of the manufacturers are engaged in Life Cycle Analysis projects and focus on the ecodesign of their products.
- Ultrasound equipment is much less complex, including fewer components compared to other modalities in the medical imaging sector. Taking ultrasound as example was easier and faster to learn and to develop a methodology, to establish company internal processes to assess environmental aspects, create targets, and to change technologies.

2.3. GENERAL DESCRIPTION OF ULTRASOUND EQUIPMENT

Ultrasound is an imaging technique used to visualize subcutaneous body structures including tendons, muscles, joints, vessels and internal organs for possible pathology or lesions. Obstetric ultrasound is commonly used during pregnancy to check on the development of the fetus.

Ultrasound uses a piezoelectric transducer encased in a probe to send pulses of sound into the body. The sound wave is partially reflected at each point in the body where a tissue interface results in a change in density. The time it takes for the echo to travel back to the transducer is measured and used to calculate the depth of the tissue interface causing the echo. The greater the difference in density, the larger the echo is.

The sound is focused either by the shape of the transducer, a lens in front of the transducer, or a complex set of control pulses from the ultrasound scanner machine. This focusing produces an arc-shaped sound wave from the face of the transducer. The wave travels into the body and comes into focus at a desired depth.

Typical ultrasound scanners operate in the frequency range of 2 to 18 megahertz, hundreds of times greater than the limit of human hearing. The choice of frequency is a trade-off between spatial resolution of the image and imaging depth. Superficial structures such as muscles, tendons, testes, breast and the neonatal brain are imaged at a higher frequency (7-18 MHz), which provides better axial and lateral resolution. Deeper structures such as liver and kidney are imaged at a lower frequency 1-6 MHz with lower axial and lateral resolution but greater penetration.



Figure 3: ultrasound equipment

¹⁴ Aloka has been acquired by Hitachi in 2012

¹⁵ Medison has been acquired by Samsung in 2012



2.4. MARKET COVERAGE

The ✓7 companies¹⁶ participating in the ultrasound pilot project had a total turnover in Europe in 2013 of ✓737,4¹⁷ million euros covering around 82%¹⁸ of the European market.

Table 4: Ultrasound - EU¹⁹ market data

Modality	2011 Market Value	2012 Market Value	2013 Market Value	Estimated EU Market Coverage
Ultrasound (US)	✓788 M€	✓740 M€	✓737,4 M€	82%

2.5. SRIV1 METHODOLOGY FOR ULTRASOUND

Participating companies developed a generic process to be followed for the pilot ultrasound. A detailed description of each process phase is described in the SRIV1.

2.6. TARGET SETTING

The industry SRI SC set a target to reduce in 2012 the average annual energy consumption per unit of new ultrasound products placed on the market by 25% compared to the 2005 baseline. The target was set on the basis of an expert judgment on realistic feasibility to improve the already existing ecodesign programs.

To reach the 25% target, according to table 2, participating companies reduced the average annual energy consumption per unit by ✓14,5% from 2009 to 2012.

The average annual energy consumption per unit has been reduced despite new products had increased functionality and delivered even more healthcare benefits to patients.

The target to reduce average annual energy consumption of new ultrasound products placed on the market by ✓14,5% between 2009 and 2012 translates to a reduction in average annual energy consumption from ✓809 kWh per unit per year in 2009 down to 691 kWh per unit per year in 2012.

Participating companies achieved the target by setting the following objectives:

- Increased focus on ecodesign in the product design and development process. For example, considering the use of the International Standard IEC 60601-1-9: Environmentally Conscious Design of Medical Electrical Equipment
- Specify and design product components and parts with much less energy consumption
- Using new technologies (e.g. Green IT equipment)

¹⁶ SRI Member : GE Healthcare, Hitachi Medical Systems Europe, Philips Healthcare, Siemens Healthcare, Toshiba Medical Systems Europe, Hitachi, Samsung.

¹⁷ COCIR SHARE internal market statistics data base. Data are based on the fiscal year.

¹⁸ Estimation provided by companies based on SHARE data

¹⁹ COCIR Imaging Market Statistics source (SHARE). Countries included: Estonia, Latvia, Lithuania, Bosnia, Bulgaria, Croatia, Czech Republic, Hungary, Poland, Romania, Serbia, Slovakia, Slovenia, Ukraine, Portugal, Spain, Denmark, Finland, Norway, Sweden, Ireland, UK, Austria, Belgium, France, Germany, Greece, Italy, Netherlands, Switzerland, Albania, Macedonia.

APPENDIX III

3. MAGNETIC RESONANCE IMAGING EQUIPMENT

3.1. GENERAL DESCRIPTION OF MAGNETIC RESONANCE EQUIPMENT

Magnetic resonance imaging (MRI) is a medical imaging technique used in radiology to visualize detailed internal structures of the human body. MRI makes use of the property of magnetic resonance of nuclei to create medical diagnostic images.

An MRI machine utilizes superconductor technology by using liquid Helium (below 4.2 Kelvin) to create a powerful magnetic field to align the magnetization of atoms within the body. Radio frequency waves are used to systematically alter the alignment of this magnetization. This causes the nuclei to produce a rotating magnetic field detectable by the scanner. Very powerful magnetic field gradients are needed to cause nuclei at different locations to rotate at different speeds providing the necessary 3-D spatial information. The information collected is manipulated with high speed mathematical formulas to generate extremely detailed medical diagnostic images.

MRI provides excellent contrast between the different soft tissues of the body, which makes it especially useful in imaging the brain, muscles, internal organs, and cancers. Compared with other medical imaging techniques such as computed tomography (CT) or X-rays, MRI uses no ionizing radiation.

MRI technologies

MRI equipment uses two different technologies to generate the required magnetic field strength that could vary from 0,35 Tesla up to 7 Tesla or even more.

Permanent magnet: permanent magnets are used to generate magnetic field up to 1,2 Tesla. Commonly such models are equipped with non-cylindrical magnets allowing more patient comfort. Non cylindrical magnet MRIs are called "Open MRI".

Superconductive magnet: superconductive electromagnets, cryo-cooled to 4 Kelvin using liquid helium, are used to generate magnetic fields up to 7 Tesla or more. The boiled helium is re-condensed by a cryo-cooler (Gifford-McMahon or pulse tube). The cryo-cooling system cannot be switched off except in case of emergency. This causes the helium to boil off and get lost. Normally superconductive MRIs use cylindrical magnets but sometimes open magnets.



Figure 4: Open MRI and cylindrical MRI

Magnetic field strength

The strength of the magnetic field and the power of the gradient coil and the RF senders determine the quality and resolution of the image. High end machines for hospital use are equipped with 3 Tesla magnets. Higher fields equipment, up to 7 Tesla, are actually under development and test and used only for research purposes.

Bore size

The bore diameter is important for patient comfort. Patient suffering from claustrophobia could experience better comfort in larger bores. Moreover, large bores allow the examination of "big" patients suffering from obesity. Nonetheless larger bore size requires the use of more powerful and energy consuming magnet systems and gradient coils, as the field strength decrease with the distance.

3.2. MODES

Three modes have been defined for MRI equipment.

Off mode:

The MRI is in the lowest user selectable power state. In superconductive MRIs the magnet needs to be cooled permanently²⁰. Therefore, the cooling circuitry and the magnet supervision needs to be active.

Ready-to-scan mode:

The MRI is on and ready to acquire an image. All modules are active. However, neither gradient pulses nor radio frequency waves are sent or received. The computing system may calculate and display images from raw data previously acquired.

Scan mode:

The MRI is actively scanning the patient by sending high frequency waves as well as gradient pulses and reading the resulting variations in the magnetic field. The computing system acquires the corresponding data and calculates and displays images.

The power consumption of MRI in the three modes is represented in figure 5.

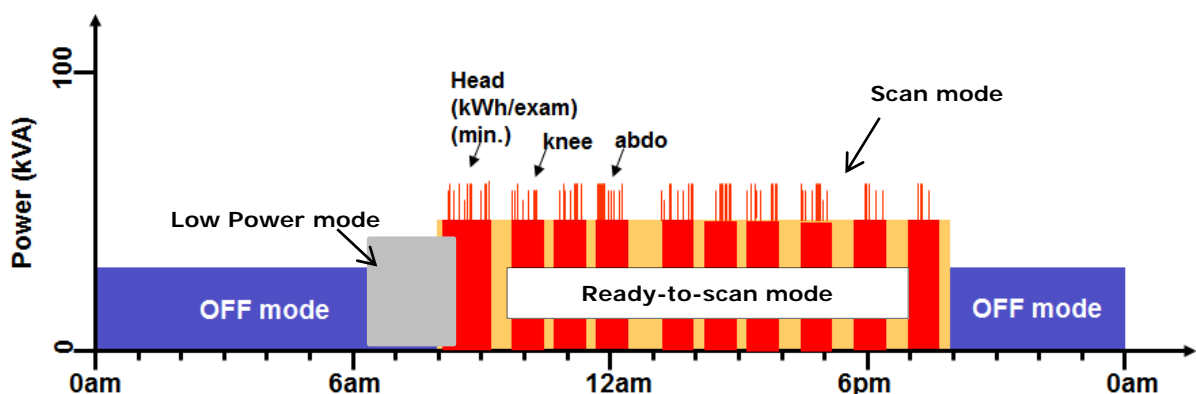

Figure 5: Exemplary power consumption of MRI

²⁰ In case the magnet cooling system is switched off, the helium slowly boils and it is released. The released helium is lost and needs to be replaced by liquid helium. This implies the corresponding cooling and transporting efforts.

3.3. POWER CONSUMPTION

The measurements performed on all models allowed to determine the energy consumption of MRI equipment in the different operating modes, according to the defined use scenario (Appendix III.II.IV).

Even if the variability between different MRI is relevant, the following average values can be identified equipment:

MODE	Average Power Consumption (kW)	Average distribution of daily energy consumption %
Off	9,3	34
Ready to scan	14,6	34
Scan	22,3	32

The power consumption in scan mode cannot be easily measured as it is different for each sequence and moreover it varies extremely during the same sequence as shown by figure 6. For each sequence the average power consumption has to be derived.

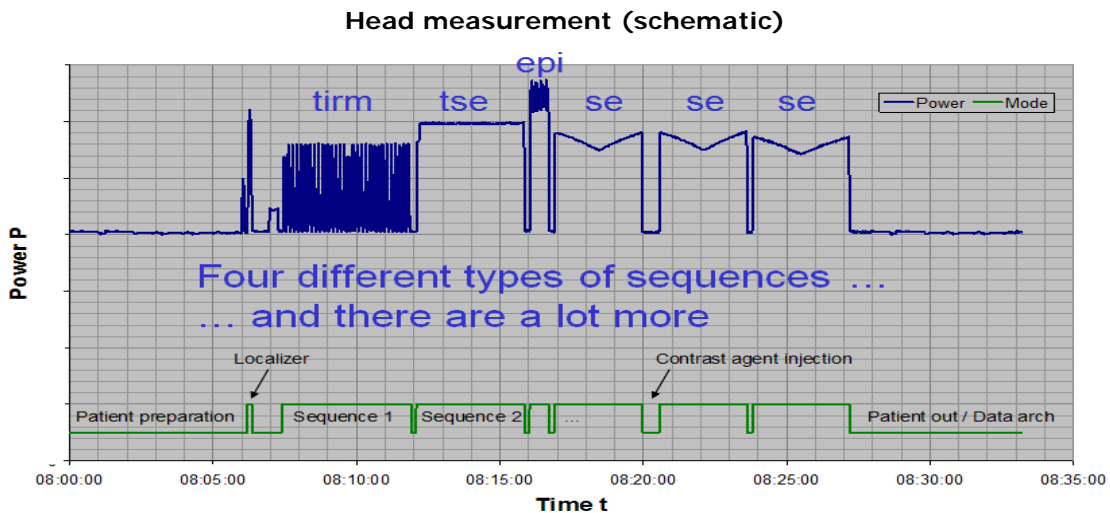

Figure 6: Power consumption for different sequences in abdomen examination



3.4. MARKET DATA

The ✓5 companies²¹ participating in the SRI for the MRI sector represent a total turnover in Europe of ✓762²² million euros in 2015, covering about 100%²³ of the European market.

Table 7: MRI – EU²⁴ market data

Modality	2013 Market Value	2014 Market Value	2015 Market Value	Estimated EU Market Coverage
Magnetic Resonance Imaging (MRI)	✓600 M€	✓677 M€	✓762	100%

3.5. IDENTIFICATION OF THE MOST SIGNIFICANT ENVIRONMENTAL ASPECT FOR MRI

Magnetic resonance Imaging equipment has been chosen by the Steering Committee as the first modality to be targeted on the base of Step 1 and Step 2 of the methodology as shown in table 5.

According to Step 3 of the methodology, data provided by companies are used to rank the different environmental aspects. Table 8 shows that energy consumption during the product lifecycle use phase has been identified as the top environmental aspect.

Table 8: Identification of most significant environmental aspect

Identification of most significant environmental aspect		
Aspects	Average internal ranking	Final COCIR Ranking
Energy use	1	1
Non ferrous metals	2	3
Ferrous alloys	3	4
Helium consumption	2	2
Magnet metals	3	5
Copper in Gradient coil	4	8
Copper: end of life	2	6
Copper: production	3	7

²¹ GE Healthcare, Hitachi Medical Systems Europe, Philips Healthcare, Siemens Healthcare, Toshiba Medical Systems Europe

²² COCIR SHARE internal market statistics data base

²³ Estimation provided by COCIR companies based on 2015 SHARE data

²⁴ COCIR Imaging Market Statistics source (SHARE). Countries included: Estonia, Latvia, Lithuania, Bosnia, Bulgaria, Croatia, Czech Republic, Hungary, Poland, Romania, Serbia, Slovakia, Slovenia, Ukraine, Portugal, Spain, Denmark, Finland, Norway, Sweden, Ireland, UK, Austria, Belgium, France, Germany, Greece, Italy, Netherlands, Switzerland, Albania, Macedonia.



3.6. COMPLEMENTARY DOCUMENTATION

This report is completed by the following documentation:

1. Magnetic resonance Equipment (MRI) - Study on the potential for environmental improvement by the aspect of energy efficiency

The SRI Steering Committee hired in July 2011 an external consultant with long experience in the field of ecodesign, PE International, to study the potential for improvement of MRI equipment with regard to energy efficiency. The study analyses MRI energy consumption, the allocation of power usage in the different modules during off, ready-to-scan and scan mode and technological solutions to improve the efficiency.

Results of the study are used as input for Step 4 of the SRI methodology for setting the ecodesign target for MRI.

2. Magnetic resonance Equipment (MRI) - Measurement of energy consumption

The SRI Steering Committee mandated in October 2010 an Expert Working Group on MRI with the objective to develop a methodology to measure the energy consumption as there are no recognized standards at the moment. The measurement methodology allows company to measure the energy consumption of MRI on a common basis providing comparable data that are used in Step 4 of the SRI methodology.

3.7. MEASUREMENT OF THE ENERGY CONSUMPTION

The SRI Steering Committee started in October 2010 to develop a methodology to measure the energy consumption of MRI equipment, as there are no available standards that could be used.

The methodology ensures that:

- Results of the measurements are comparable and repeatable
- The measured energy consumption has a strict relation with the real energy consumption in everyday hospital use. Such information is important for hospitals and clinics to understand the real running cost of MRI to plan and allocate correctly their budget
- The procedure does not involve disproportionate costs or resources
- The measurement results allow the determination of all the information that could be considered relevant for the SRI target setting process but could also be useful for MRI users.

A first methodology was defined in May 2011 and participating companies started a measurement campaign providing a first set of 5 measured machines. After a deep analysis of the data the methodology was simplified by introducing average values for the ready-to-scan mode durations (see the "Magnetic Resonance – Measurement of energy consumption" document for additional information). Participating companies measured all their MRI models according to the new methodology.

The study on the MRI potential for improvement showed that the energy use in scan mode could not be reduced due to physics of the process which requires a certain amount of energy (see "Magnetic resonance Equipment (MRI) - Study on the potential for environmental improvement by the aspect of energy efficiency").

For the above mentioned reason, the SRI adopted a simplified version of the methodology without measuring the energy consumption in scan mode (for additional information see Appendix III.V).

The methodology has been finalized in February 2012 and is available for download at COCIR website.



3.7.1. MEASURING THE ENERGY CONSUMPTION

The energy consumption could normally be calculated by summing the energy consumption in each mode, calculated multiplying the power consumption for each mode for the relative duration:

$$\text{Energy use} = T_{\text{off}} * P_{\text{off}} + T_{\text{ready-to-scan}} * P_{\text{ready-to-scan}} + T_{\text{scan}} * P_{\text{scan}}$$

The average power draw in off mode, servicing mode and ready-to-scan mode can be easily measured. For MRI the following elements are unknown:

$T_{\text{ready-to-scan}}$: Duration of ready to scan mode
T_{scan}	: Duration of scan mode
P_{scan}	: Power consumption in scan mode

Those durations depend very much on which examination is performed, the scan speed of the machine and the administrative operations to be performed by doctors during the examination (patient preparation, data input, data archiving, patient positioning, etc.).

While for off mode it is easy to set an average value according to hospital practices, setting average values for the remaining two modes would not allow to take into consideration a very important factor, the "productivity" of the MRI, the number of patients that can be examined per day (see chapter II.V).

3.7.2. SYSTEM BOUNDARIES

The SRI SC defined the system boundaries (which modules should be included in the measurement and which not) for the measurement of MRI equipment.

In: All system-critical items needed to perform a basic scan, e.g. gradient amplifiers, RF unit, MR coils needed for the specific measurements, reconstruction engine(s), required electronics such power supplies, controllers, console/computer, cryogen compressor, water heat exchanger, patient table, magnet, helium-conservation equipment.

Out: Any equipment and accessories beyond basic product offering and not required for a basic scan, or customer-provided equipment, e.g. optional MR coils, patient vital signs accessories, facility-provided cooling water equipment and hardware for advanced medical applications.

3.7.3. EQUIPMENT CONFIGURATION

To allow comparability of the measurements the SRI SC identified ranges for the values of the most relevant parameters for each one of the defined sequences having an impact on the energy consumption:

- Number of slices
- Field of view
- Slice thickness
- Resolution
- Bandwidth
- Sequence duration

As shown in table 9, a set of parameter has been defined for each sequence. The values have been determined on the basis of the experience of companies' experts as the most commonly used in hospital practice.

Moreover, the values have been validated according to the following documentation:

- the German "Guidelines of the Federal Medical Council for Quality Assurance of magnetic resonance imaging" (BÄK)
- and the "guidelines on criteria for quality assessment in nuclear magnetic resonance imaging pursuant to § 136 SGB V i.V.m. § 92 SGB V, Section 1 of the Federal Committee of Physicians and Sickness Funds (Quality assessment guidelines for



magnetic resonance imaging)

For each parameter and for each sequence the minimum or maximum value is indicated in the table.

Table 9: Abstract from the configuration parameters table. The complete table is available in the “MRI – Measurement of energy consumption” document.

	Number of Slices	FOV(mm ²)	Slc Thk (mm)	Resolution	Bandwidth (Hz/Px, Range)		Sequence
	Minimum	Max	Max	Max	Min	Max	
HEAD							
localizer	1	280	8	1,1	290	655	
t2_tirm_tra_dark-fluid_320	28	220	5	0,7	191,0	200	
t2_tse_sag_512	27	250 x 225	5	0,5	122,0	195	
ep2d_diff_3scan_trace_p2	23	240	5	1,9	1132,0	4000	
t1_se_tra_320	28	230	5	0,8	150	160	
t1_se_tra_320	28	230	5	0,8	150	160	
t1_se_cor_320	32	230	5	0,8	150	200	
SPINE							
localizer	5	450	8	1,8	290	655	
t2_tse_sag_512	16	300	3	0,6	160	165	
t1_tse_sag_512	15	300	4	0,6	240	250	
t2_tse_tra_512	20	230	4	0,5	95	195	
t1_tse_tra_448	20	230	4	0,6	110	230	
ABDOMEN							
localizer	5	450	8	1,8	450	655	
t1_f12d_opp-in_tra_p2_mbh	30	380	6,0	1,5	240	525	
t2_trufi_cor_p2_bh	25	400	6,0	1,4	500	655	
t2_tse_tra_p2_mbh_320	30	380	6,0	1,2	260	395	
t1_vibe_fs_tra_p2_320_bh_pre	64	400	4	1,3	400	785	
t1_vibe_fs_tra_p2_320_bh_arterial	64	400	4	1,3	400	785	
t1_vibe_fs_tra_p2_320_bh_venous	64	400	4	1,3	400	785	
t1_vibe_fs_tra_p2_320_bh_delayed	64	400	4	1,3	400	785	
t1_vibe_fs_cor_p2_bh_288_post	128	400 x 360	4	1,4	600	870	
KNEE							
localizer_tra	3	450	8	1,8	250	656	
localizer_saq+cor+tra	3	300	5,0	1,0	250	435	

3.7.4. MRI USE SCENARIO

To define the functional unit, the use scenario must first be defined. The use scenario includes applicable use modes, typical customer applications, and equipment capability. Use modes²⁵ in view of the measurement of the energy consumption are defined as:

Off mode: The system functions into the minimum energy consumption state that the typical user can access e.g. through selection of off or shutdown, at the operator console.

Ready-to-scan mode: This mode represents the state of the system during patient handling and/or data evaluation and archiving, between individual scans.

Scan mode: The MRI is actively scanning the patient to generate images by sending high frequency waves and gradient pulses and reading the resulting variations in the magnetic field. The computing system interprets the data and generates the images.

To determine the time an MRI system remains in each mode, participants referenced confidential

²⁵ The low power mode defined in the MRI measurement methodology is not reported here as its power consumption has been assumed equal to ready-to-scan mode.



field usage records and estimated average values that could represent daily usage of MRI.

To evaluate the energy consumption, the most commonly used examinations were estimated by application specialists. Such values are also supported by external studies such as the "2007 MRI Market Summary Report", May 2008, IMV Medical Information Division²⁶. This mix served as the "standard application mix" on which basis specific MRI protocols were defined and performed. Members agreed to use the top 5, normalized to 100% as shown in table 10.

Table 10: Scan Mode application mix

Diagnostic Application	Normalized Distribution
Head	23,8%
Spine	24,8%
Abdomen	23,8%
Knee	19%
Angio	8,6%

According to companies' experts the following daily usage has been defined:

Off:	12h (Off mode)
Scan, ready-to-scan:	10h (Ready-to-scan + scan mode)
Low power:	2h (Reduced power consumption)

3.7.5. PATIENTS PER DAY

A very important feature of MRI is the patient/day ratio. The patient/day ratio measures the maximum number of patients (or examinations) that a MRI machine could scan in one day according to the examination distribution (use scenario) set as typical by the measurement methodology.

This value is determined by performing each examination (head, spine, abdomen, knee, angio) using phantoms²⁷ but with real patient measurements (e.g. contrast agent injections, table moves, patient breath holds, etc). Using the distribution provided by the use scenario, it is possible to determine how many examinations could be performed in one day (how many patients could be examined per day).

The patient/day ratio is very important for at least 2 main reasons:

- The productivity of the machine represents high value information for the user (hospital/clinic).
- There is a linear correlation between the productivity and the energy consumption. MRI with higher patient/day ratio consumes more energy as shown by figure 7.

This means that MRIs with lower performances in terms of patients per day are usually consuming less energy. Reducing the number of patients per day could help reducing the energy consumption of MRI equipment. On the other hand, this is not acceptable as medical companies are committed to deliver equipment with improved performances/shorter examination times for patients.

As the technological evolution is moving towards machines with faster scan time and higher patient throughput (higher productivity) the energy consumption in absolute value could be

²⁶ www.imvinfo.com.

²⁷ Phantoms are models made of plastic and fluids that simulate body parts and are used to test and calibrate MRI equipment.

expected to grow accordingly.

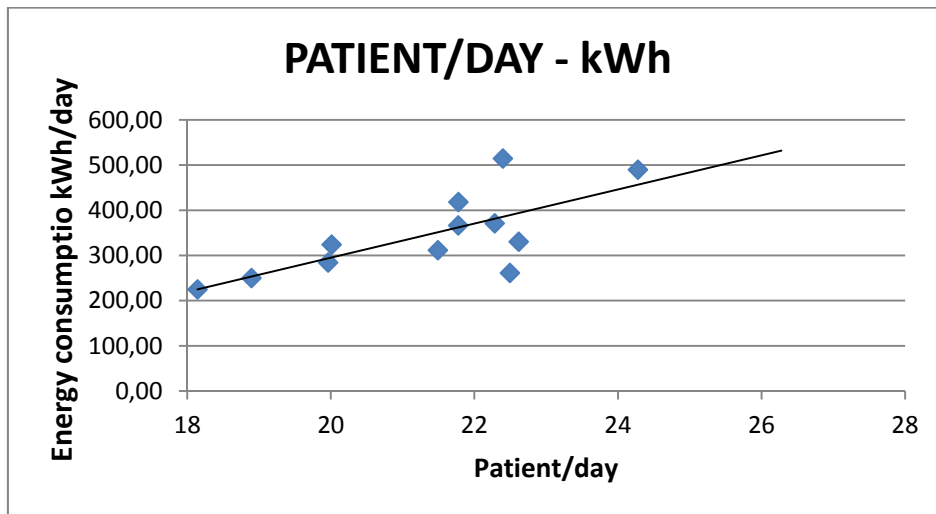

Figure 7: Correlation between patient/day and total energy daily consumption, measured on 12 MRI.

3.7.6. SIMPLIFIED MEASUREMENT METHODOLOGY

As the Steering Committee decided to measure only the energy usage in off and ready-to-scan mode (see chapter III.V), the "Methodology for the measurement of the energy consumption of MRI" has been applied in a simplified version.

Moreover, the power draw in low power mode as defined in methodology description has been assumed equal to the power draw in ready-to-scan mode.

3.7.7. THE METHODOLOGY IN BRIEF

The methodology requires and explains how to measure the following data needed for the SRI:

1. Power consumption in off mode
2. Power consumption in ready-to-scan mode
3. Duration of each one of the defined sequences

The duration of each examination is calculated as the sum of the time in scan mode (measured) and the time in ready-to-scan-mode (average value derived by companies' experience and first simulations).

An evaluation spreadsheet calculates the following values:

1. Number of examinations per day: calculated from the duration of each examination and the examination distribution in the use scenario during 10 hours daily working time.
2. Energy consumption in off mode: calculated multiplying the power consumption in off mode by 12 hours
3. Energy consumption in ready-to-scan mode: the energy consumption of each examination is calculated multiplying the measured power consumption for the duration of ready-to-scan. The total energy consumption per day is obtained multiplying such values for the number of examinations per day.

All the details and procedures on how to measure the energy consumption are presented in the "Magnet Resonance Equipment (MRI) – Measurement of energy consumption" document, available on the COCIR website.



3.7.8. REQUIRED RESOURCES TO PERFORM THE MEASUREMENTS

The measurement methodology requires the MRI to be available in a test lab. In alternative the test could be performed in a hospital or clinic environment.

The following tasks and technicians/specialists are required to measure one specific target MRI equipment:

TASK	TIME	
Compilation of the sequences	4h	Application specialist
Installation of the measurement tool	1h	Electrician
Preparation of the templates	1h	Specialist
Running the sequences	3h	Specialist, Measurement specialist
Measurement of Off mode and de-installation of measurement tool	1h	Specialist, Electrician, Measurement specialist
Data archiving	1h	Application specialist
Data evaluation	4h	Specialist
Total	20h	

3.8. ECODESIGN TARGET FOR MRI

3.8.1. SRI METHODOLOGY FOR ECODESIGN TARGET SETTING IN BRIEF

The fourth step of the SRI methodology sets the eco-design target as the market average performance of the selected aspect, to be achieved in a time equal to the specific innovation cycle.

The SC Secretariat collects from companies the measurements of all MRI models and, on the basis of the reduction potentials determined by the PE INTERNATIONAL study on MRI, calculates the target scenarios²⁸:

- Baseline today
- Business as usual (BAU)
- Best not yet available technology (BnyAT)
- Beyond Business as usual.

Based on these scenarios, the SRI SC decides on a feasible industry reduction target. Before it is approved, the industry target is proposed to the European Commission for discussion.

3.8.2. MRI CATEGORIES

The SRI SC recognized that MRI equipment has different design intents, for specific clinical applications. The design intents result in energy consumption which is substantially different, due in large part to MR physics. For instance, a growing clinical need is for MRI systems with a large patient access (bore). Since MR physics is based on pulse sequences (switched magnetic field gradients and radio frequency pulses), the power needed for the pulse sequences increases as the diameter increases. Other features relevant to different image quality needs, such as number of data receiver channels, also affect energy consumption. It was recognized that a simple energy metric might cause confusion if systems with different clinical utilities are compared directly. As a result, member companies have developed a categorization table (see table 11).

²⁸ For additional information on scenarios refer to SRIV2 documentation, Appendix V: www.cocir.org

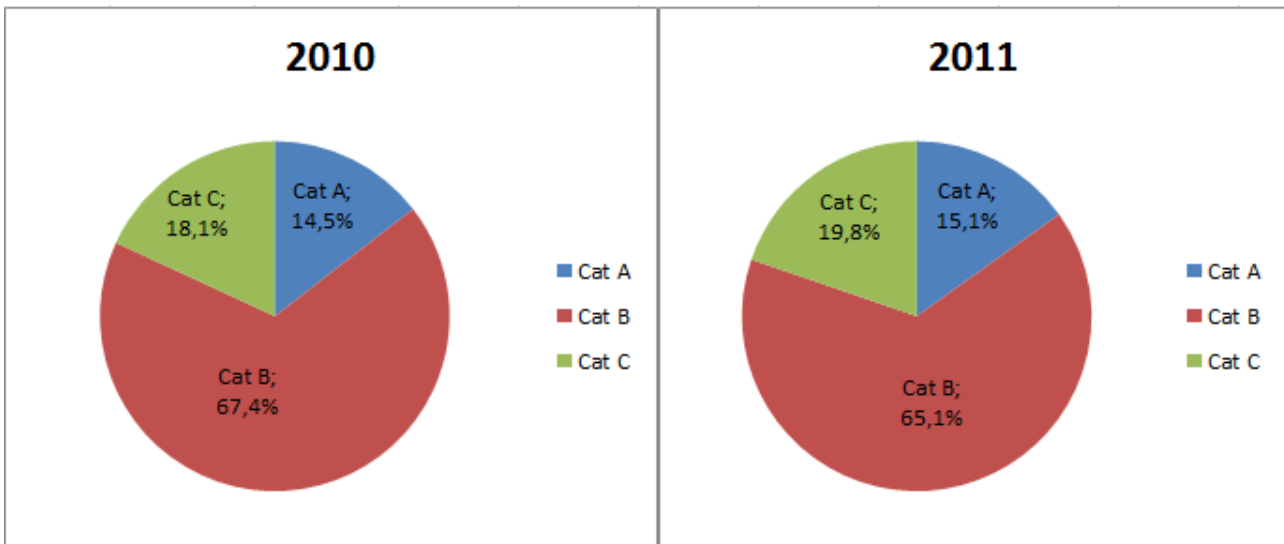

Table 11: MRI Equipment Categorization Table

General information on categories included	<ul style="list-style-type: none"> - matrix columns represent key differentiation characteristics that differentiate different clinical utilities of a system - each characteristic results in a designated amount of points - total score of all characteristics will determine the overall category that a system belongs to 			
Key characteristics	<u>Field strength</u>	1.5T	50	points
		3.0 T	100	points
	<u>Bore size</u>	< 60 cm	10	points
		≥ 60 & < 70 cm	20	points
		≥ 70 cm	30	points
	<u>Maximum Gradient Amplitude per axis</u>	< 35 mT/m	40	points
		≥ 35 mT/m	80	points
	<u>Maximum Slewrate per axis</u>	< 100 mT/m/s	20	points
		≥ 100 mT/m/s & < 150 mT/m/s	30	points
		≥ 150 mT/m/s	40	points
	<u>Patient table</u>	fixed table	10	points
		mobile table	20	points
	<u>Maximum channels</u>	< 16 channels	15	points
		≥ 16 channels & < 64 channels	35	points
	≥ 64 channels	45	points	
<u>Useable FOV cm²</u>	< 40 cm	25	points	
	≥ 40 & < 50 cm	35	points	
	≥ 50 cm	45	points	
Final company model category	Total points			
	Clinical model - Category A		< 220	points
	Hospital model - Category B		≥ 220 & < 315	points
	Research model - Category C		≥ 315	points

The MRI units sold in 2010 and 2011 are reported in figure 8 in percentage according to the 3 identified categories.

Figure 8²⁹: MRI – Distribution of units sold* in 2010 and 2011 in EU³⁰



*Open magnet units are not included in the figures as they are not in the scope of the SRI

3.8.3. SCOPE

The SRI Steering Committee decided to apply the SRI methodology to set ecodesign targets only to category B equipment.

Exclusion of category A

Category A products represent a small percentage of the whole sales in EU as shown by figure 8. Most of category A MRI are open models equipped with permanent magnets that do not require power to generate the magnetic field (no cryo-cooling system). Therefore, contribution of category A to the energy consumption of MRI is very limited and the absence of the cryo-cooled magnet reduces also the potential for improvement.

Exclusion of category C

Category C models accounts for 20% of all EU sales. Category C represents high-end models, with increased functionality, mostly used for research purposes. Only a few models are actually commercialized by few companies. If applied, the methodology would open critical issues related to confidentiality of delivered results and certainly would harm innovation.

The required high level performances involve higher energy consumption, due to the high magnetic and gradient field performance, number of receiving channels, bore and field-of-view size. For this reason, the potential for improvement is extremely limited and should be investigated with extreme care to avoid that possible technical solutions to reduce the energy consumption (adopted for category B equipment) could compromise the innovation potential.

For the above mentioned reasons the SRI Steering Committee decided not to set targets for such equipment and to evaluate the feasibility of reducing the energy consumption without compromising performances and benefits for patients.

3.8.4. FUNCTIONAL UNIT

²⁹ Figures have been updated in 2015 due to the reclassification of an MRI model by a Company

³⁰ EU 27 market data provided by companies for each model placed on the market in calendar year 2010 and 2011. As only category B products have been included in the SRI scope, sales data on category A and C are not collected every year.



The functional unit is the reference ensuring the comparability of power consumption of different products and their developments over time.

As identified by the study on improvement potential for MRI, the functional unit for MRI is the number of patients that can be examined per day. Such number, as already presented, is not fixed a priori but depends on the hospital workflow, the administrative time, the nature of examinations, the required quality and functionality and furthermore the power and performance of the machine. It is determined measuring the duration of each examination (scan time: measured + ready-to-scan time: set) and applying the examination distribution to the 10 hours working time of the machine.

3.8.5. METRIC – ENERGY CONSUMPTION IN OFF AND READY-TO-SCAN ONLY

The energy consumption of MRI is the sum of the energy consumption in the three different modes (off, ready-to-scan and scan).

The initial measurements run on 12 models and the results of the study on MRI potential for improvement have shown that:

1. Measuring the energy consumption in scan mode is complex, expensive and time consuming, as examined in Appendix II.I.
2. The potential for reducing the energy used to perform the scan is limited due to the physics of the process. A certain amount of energy is needed to stimulate the response from the body and to be read by receivers.
3. Improvements in scan mode could be achieved by defining new technologies that use different sequences with less energy needed. Such improvements could not be recorded by the methodology at the moment, as the sequences are set. Not setting the sequences would render difficult to compare the measurements as it changes the functional unit.

Therefore, the SRI Steering Committee **decided to not consider the energy in scan mode for the determination of the ecodesign target.**

The adopted metric for setting the target for MRI is **the energy usage per model per day (kWh/unit day) in off and ready-to-scan mode to perform a certain number of examinations according to the use scenario.**

The target is to be expressed as the **average daily consumption per model in off and ready-to-scan mode:**

$$\text{kWh}_{(\text{off, ready-to-scan})} / \text{unit day}$$

This choice reflects the part of the energy consumption that could be reduced by ecodesign programs and takes into account the productivity of the MRI as the time in ready-to-scan mode is not defined but varies. In fact, even if the ready-to-scan time is defined per examination, the number of examinations per day depends on the total examination time, which account also for the scan time.

3.8.6. INNOVATION CYCLE

The innovation cycle is defined as the time needed to develop new or enhanced products and place them on the market. For medical devices it could vary from 3 years to 7, depending on the complexity of the innovation being brought to market.



The below listed activities for MRI requires:

Research and development	-	1 year
Realization, Verification and Validation	-	3 years
Regulatory Approvals	-	1 year

The innovation cycle for MRI therefore corresponds to 5 years.

3.8.7. SETTING THE ECODESIGN TARGET

The SRI methodology for target setting has been developed on the base of the experience gathered with the pilot ultrasound project. In particular the Business-as-usual scenario (BAU) is based on the assumption that the energy consumption of the modality under consideration will get lower year after year due to existing ecodesign programs and due to the improvements of other technologies according to implementing regulations under the Ecodesign Directive or voluntary measures. This assumption has proven true for the ultrasound pilot project.

The PE INTERNATIONAL study on MRI shows that this assumption is not true for MRI. New functionalities, larger bore diameters, increased magnetic field strength and more powerful gradient and RF amplifiers are going to increase the energy demand to meet clinical needs of medical care.

Therefore the BAU scenario, defined under the assumption that all companies will reach the front runner today at the end of the innovation cycle, has been redefined for MRI according to the findings of the PE INTERNATIONAL study on MRI improvement potentials and used as the baseline.

According to the findings of PE INTERNATIONAL, the BAU baseline shows an increase in the energy demand which can be mitigated by the reduction of energy usage in the most favorable case (BnyAT) where all possible improvements are implemented at the same time by all companies (extreme assumption not in line with technological limits). Therefore the BnyAT scenario should be re-defined accordingly as the result of the application of the companies' potentials to the newly defined BAU baseline.

BAU Scenario³¹

PE International estimated in the BAU scenario an increase in energy consumption (off+ready-to-scan) of 16,68% assuming that by 2017, half of the category B product sold on the market will have an energy consumption comparable to the energy consumption of Category C products today.

This estimation has been reviewed later with the availability of additional measurement data and estimations provided by each Company of its own BAU scenario according to the specific corporate strategies.

An increase around 12% in the energy consumption by 2017 has been considered an assumption better reflecting the current trends.

Beyond BAU scenario and correction factors

According to the experience gathered with the ultrasound Pilot project the SRI methodology assumes that the front runner is the Company with the lowest potential for improvement. The study on Improvement Potentials coupled with measurement data showed for MRI a different situation. The front runner estimated an improvement potential that is quite high compared to other companies.

³¹ The new methodologies for the scenarios definition (BAU and BnyAT) have been included in the SRIv3 revision which has been published with this Report in 2013.



This can be interpreted as the result of extensive research in ecodesign that allows the front runner to foresee the application of technical solutions that are not evident to other companies to improve the energy performances. **This represents an important example of how ecodesign could drive innovation.**

Applying the SRI methodology under this circumstances is not possible, otherwise the industry target will result even higher than what has been estimated as the highest possible improvement.

The SRI Steering Committee decided to use correction factors applied to the individual company maximum improvement to derive the company targets and the Industry targets (weighted average against sales). It has been assumed that companies could achieve 75% of the maximum possible improvement and 50% for the front runner to take into consideration the higher marginal costs.

Scenarios

The four scenarios have been redefined accordingly as:

- **Baseline today**
- **Business as usual scenario (BAU) according to the SRI v2 methodology**, used as reference value and showing the fleet performance of the front runner.
- **Business as usual (BAU) according to the SRI v3 methodology**: scenario for year 2017 where the average daily energy usage per model is expected to be increased around 12% compared to baseline today.
- **Best not yet available technology (BnyAT)**: scenario for year 2017 where the average daily energy usage per model is expected to decrease around 5,4% compared to the baseline 2011.
- **Beyond Business as usual**: scenario for year 2017 derived applying correction factors to companies BnyAT where the application of the SRI will compensate the increase in energy consumption due to added functionalities maintaining the energy consumption constant (0,73% decrease compared to the 2011 baseline).

The maximum possible reduction potential identified for each Company is used to calculate the average value, **15,63%**, that is used to define the Best-not-yet-available scenario. The PE International study collected the individual company data that cannot be disclosed due to confidentiality reasons.

The four scenarios calculated on all 14 measured models in category B are indicated in the following table:

Scenario (kWh/unit day)	Company					Average daily consumption in off and ready- to-scan per unit (kWh/d)	Range for setting targets compared to baseline 2011
	A	B	C	D	E		
BASELINE 2011 (kWh/d)	XX	XX	XX	XX	XX	227,4	
BAU 2017 according to SRI methodology	XX	XX	XX	XX	XX	176	Front runner fleet performance
BAU 2017 (kWh/d)	XX	XX	XX	XX	XX	254,9	+12,07%
BnyAT 2017 (kWh/d)	XX	XX	XX	XX	XX	215,2	-5,38%
Beyond BAU 2017 (kWh/d)	XX	XX	XX	XX	XX	225,8	-0,73%

■ Grey cells: confidential data



The baseline scenario is obtained as the weighted average of the energy performance of all models in kWh_(off+ready-to-scan)/unit·day against the sales³².

The result means that companies producing MRI equipment participating in the SRI commit not to increase the energy consumption in off and ready-to-scan mode of the average model in 2017 compared to the 2011 baseline. If the SRI was not in place, the energy consumption would have increased around 12% by 2017.

Table 12: Calculated values for year 2010-2011³³ and forecast until 2017 under the assumption of a linear trend.

	Sold units ³⁴	Total daily energy consumption (kWh) ³⁵	Average daily energy consumption per unit (kWh/d)	Beyond BAU	BAU
2011	✓394	✓89.011	✓225,92		
2012				225,61	230,39
2013				225,30	234,87
2014				225,00	239,34
2015				224,69	243,81
2016				224,38	248,29
2017				224,07	252,76

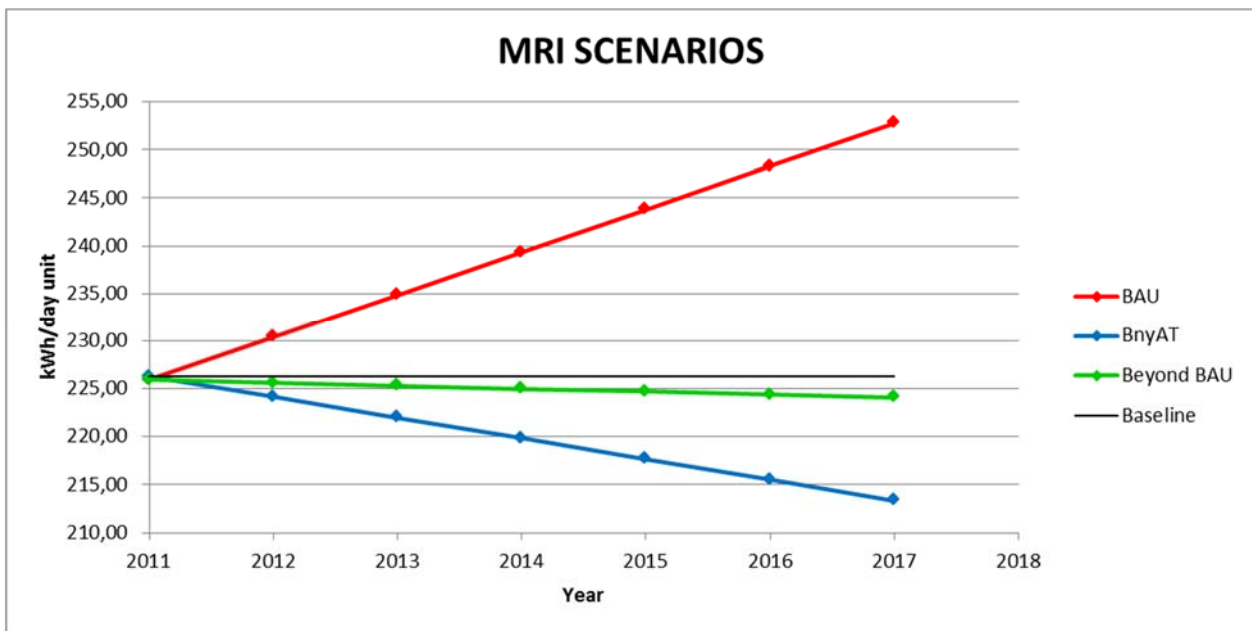

Figure 9: MRI target scenarios

³² This value differs slightly from the baseline value of the PE INTERNATIONAL study as the study identified the improvement potential of a representative model therefore considering a simple average of the measured models. Therefore the data presented in this report better reflects market reality.

³³ Values are slightly different from the ones in SRI Report 2012 due to a retrospective re-categorization of products by one company causing a variation of SRI sales and related energy consumption data of 0,15% in 2011 and 0,13% in 2012 compared to the values reported in previous SRI Status Reports

³⁴Sold units data provided by companies for each model placed on the market in the calendar year 2011

³⁵Measured energy consumption data provided by companies for each model placed on the market in the calendar year 2011.



3.8.8. COMPANY TARGETS

According to the SRI methodology, each member company adopts an internal company target which enables achievement of the industry target.

Every year the SRI SC Secretariat can evaluate the achievement of each company by comparing the baseline with the measured average performance of all models from each company placed on the market each year.

As the improvement is not a linear process only at the end of the 5 years period it would be possible to evaluate whether the Company targets have been achieved or not.

Member company targets are confidential unless a company wishes to disclose its own.

3.9. RELATIONSHIP BETWEEN SCAN AND READY-TO-SCAN KWH

Figure 10 represents the relationship between the energy use in scan mode and the energy use in ready-to-scan mode measured on 12 models.

The linear regression shows a good correlation ($R^2=0,77$) which allows to determine the total daily consumption of a MRI given the consumption in off and ready to scan mode.

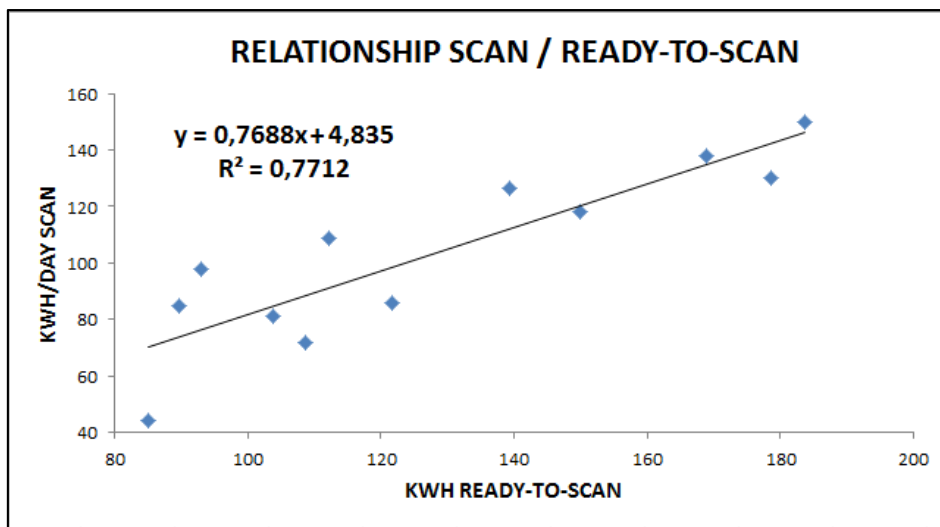

Figure 10: Linear correlation between energy consumption per day in scan mode and ready-to-scan mode in 2011

$$\text{Scan}_{\text{kWh/d}} = 0,7688 * \text{Ready-to-scan}_{(\text{kWh/d})} + 4.835$$

The relationship is valid for year 2011 and will gradually change in time due to the different trends in energy usage in the different modes.



APPENDIX IV

4. COMPUTED TOMOGRAPHY

4.1. GENERAL DESCRIPTION OF COMPUTED TOMOGRAPHY³⁶

Computed tomography is a medical imaging procedure that utilizes computer-processed X-rays to produce tomographic images or 'slices' of specific areas of the body. CT is used in medicine as a diagnostic tool and as a guide for interventional procedures. Sometimes contrast materials, such as intravenous iodinated contrast, are used. This is useful to highlight structures such as blood vessels that otherwise would be difficult to delineate from their surroundings. Using contrast material can also help to obtain functional information about tissues.

X-ray slice data is generated using an X-ray source that rotates around the object; X-ray sensors are positioned on the opposite side of the circle from the X-ray source.

Since the nineties CT scanners can process not only individual cross sections but continuously changing cross sections as the gantry, with the object to be imaged slowly and smoothly slid through the X-ray circle. These are called helical or spiral CT machines. Their computer systems integrate the data of the moving individual slices to generate three-dimensional volumetric information (3D-CT scan), in turn viewable from multiple different perspectives on attached CT workstation monitors. This type of data acquisition requires enormous processing power, as the data are arriving in a continuous stream and must be processed in real-time.

Detectors

The earliest sensors were scintillation detectors, with photomultiplier tubes excited by (typically) cesium iodide crystals. Cesium iodide was replaced during the 1980s by ion chambers containing high-pressure Xenon gas. These systems were in turn replaced by scintillation systems based on photodiodes instead of photomultipliers and modern scintillation materials with more desirable characteristics.

To be able to obtain a good quality image, detectors have to reach a specific temperature (steady state) from the off state. This process could take different times according to the specific CT and detector technology.

Reconstruction engines

Once the scan data has been acquired, the data must be processed using a form of tomographic reconstruction, which produces a series of cross-sectional images.

In terms of mathematics, the raw data acquired by the scanner consists of multiple "projections" of the object being scanned. These projections are effectively the Radon transformation of the structure of the object. Reconstruction essentially involves solving the inverse Radon transformation.

Recently, manufacturers have developed iterative physical model-based maximum likelihood expectation maximization techniques. These techniques are advantageous because they use an internal model of the scanner's physical properties and of the physical laws of X-ray interactions. Iterative techniques provide images with improved resolution, reduced noise and fewer artifacts, as well as the ability to greatly reduce the radiation dose in certain circumstances. The disadvantage is a very high computational requirement, but advances in computer technology and high-performance computing techniques, such as use of highly parallel GPU algorithms, now allow practical use.

³⁶ <https://www.medicalradiation.com>



4.2. MARKET DATA

The ✓5³⁷ companies participating in the SRI for the CT sector represent a total turnover in Europe of ✓489³⁸ million euros in 2015 and cover about 100%³⁹ of the European market.

Table 13: CT - EU⁴⁰ market data

Modality	2013 Market Value	2014 Market Value	2015 Market Value	Estimated EU Market Coverage
Computed tomography (CT)	✓454 M€	✓402 M€	✓489	100%

4.3. IDENTIFICATION OF THE MOST SIGNIFICANT ENVIRONMENTAL ASPECT FOR CT

Computed tomography equipment has resulted as the second modality to be targeted in 2012 on the base of Step 1 and Step 2 of the methodology as shown in table 5.

According to Step 3 of the methodology as summarized in chapter 3, the data provided by companies are used to rank the different environmental aspects. Table 14 shows that energy consumption during the product lifecycle use phase has been identified as the top environmental aspect, representing around 75% of the impacts on the life cycle of a CT equipment.

Table 14: Identification of most significant environmental aspect

Identification of most significant environmental aspect			
Aspects	Average internal ranking	% of total life-cycle	Final COCIR Ranking
Energy use	1	75%	1
Non-ferrous metals and alloys	2	11%	2
Ferrous metals and alloys	3	6%	3

The expert judgment provided by companies' experts shows that there is a potential for improvement, even if limited, in the energy consumption of CT. Risks have been identified regarding the impact on patient throughput and innovation. In particular extreme care should be used to ensure that the energy usage reduction is not going to affect the radiation dose or the development towards lower dosage in the future.

³⁷ GE Healthcare, Hitachi Medical Systems Europe, Philips Healthcare, Siemens Healthcare, Toshiba Medical Systems Europe

³⁸ COCIR Imaging Market Statistics source (SHARE).

³⁹ COCIR estimation based on 2015 SHARE data

⁴⁰ Countries included: Estonia, Latvia, Lithuania, Bosnia, Bulgaria, Croatia, Czech Republic, Hungary, Poland, Romania, Serbia, Slovakia, Slovenia, Ukraine, Portugal, Spain, Denmark, Finland, Norway, Sweden, Ireland, UK, Austria, Belgium, France, Germany, Greece, Italy, Netherlands, Switzerland, Albania, Macedonia.

4.4. MODES

Four functioning modes have been defined for CT equipment.

Off: The system is shut down, according to the user manual. The system consumes no energy.

Low-power: The system functions into the minimum energy consumption state that the user can select according to the user manual.

Idle mode: This mode represents a state of the system when fully powered but no scan has been prescribed. This mode does NOT include x-ray tube rotor or gantry rotation.

Scan mode: This mode represents the state of the system between individual scans and during scans (e.g. during patient handling, examination planning, contrast agent injection and active scanning with x-ray generation). This mode includes tube rotor rotation, gantry rotation and generation of image.

The power consumption of CT in the four modes is represented in figure 11 for the typical use scenario used by the SRI. Figure 12 provides a detailed overview of power draw during scan.

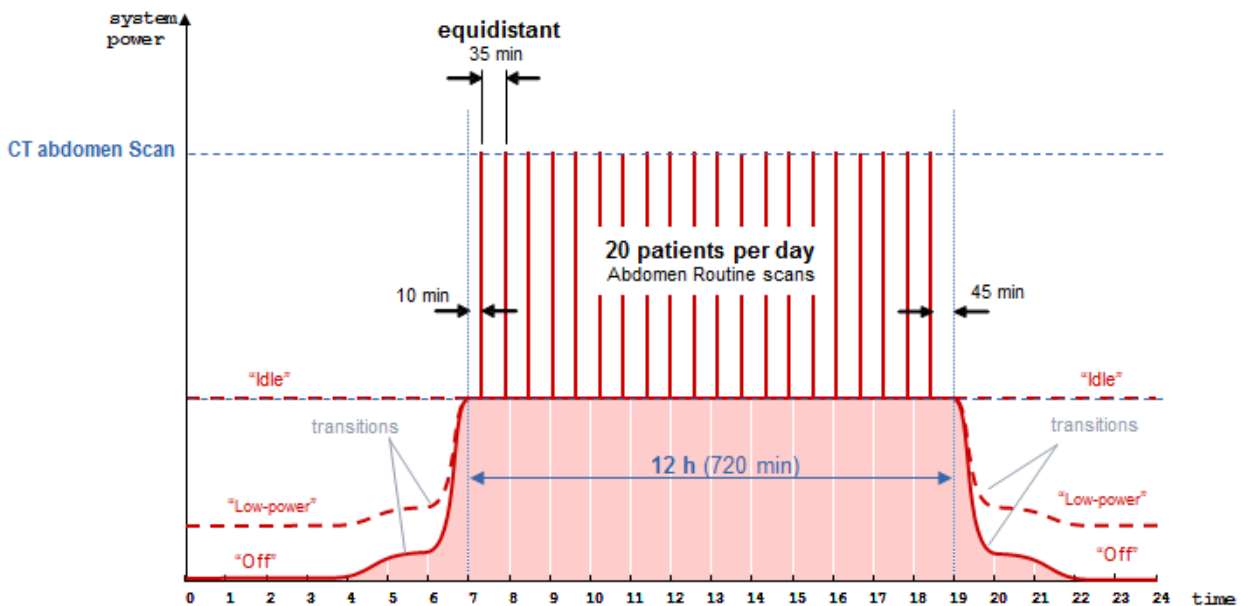

Figure 11: Power usage of a CT scanner over a typical day in hospital. The Idle mode has been simplified for illustration purposes. The 45 minutes at the end of the 12 working hours includes 35 minutes of the last scan and 10 minutes in Idle mode.

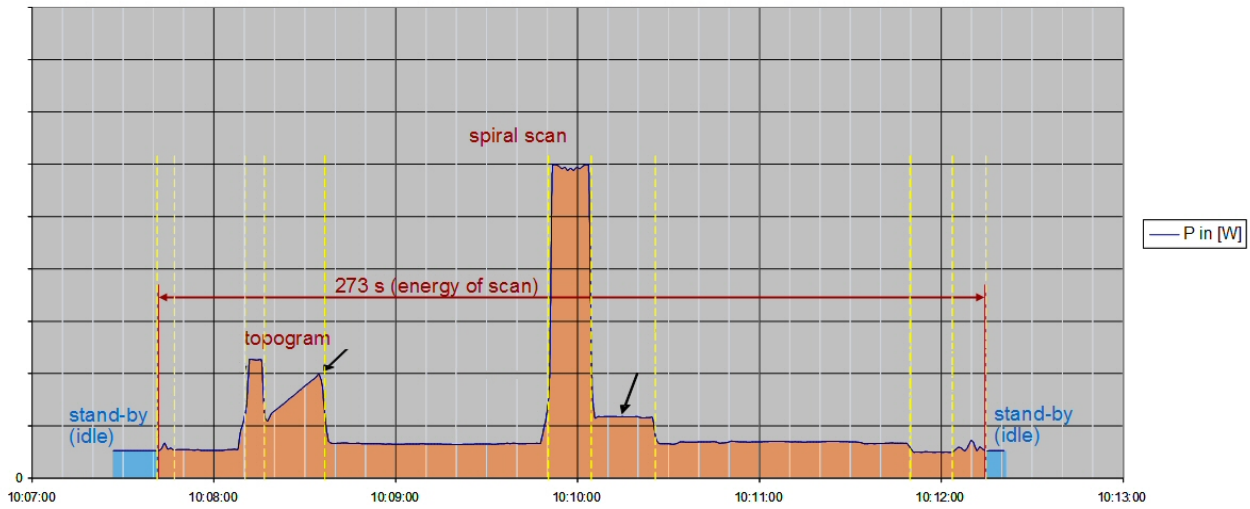

Figure 12: Exemplary power consumption of CT during scan

4.5. MODULARIZATION

The most important power consuming modules of the entire CT system have been identified⁴¹.

Tube and generator chain:	X-ray tube and all the power supplies used to power the tube and all connected devices.
Detector:	Device reading the x-ray radiation and converting it into digital signal
Power distribution unit and other power supplies	Subsystems required for electrical energy conversion and distribution
Computation, Controls:	Units dedicated to the reconstruction of the CT image and the control of the CT system
Cooling:	A collection of subsystems required for thermal management of CT components
Patient table:	Patient table with electric movement controls
Gantry Motor:	Electric motor turning the gantry around the patient during scan time.

⁴¹ PE International: Computer Tomography (CT) - Study on the potential for environmental improvement by the aspect of energy efficiency



4.6. MEASUREMENT OF ENERGY CONSUMPTION

4.6.1. HISTORY

The SRI Steering Committee started in October 2010 to develop a methodology to measure the energy consumption of CT equipment, as there are no available standards that could be used.

The methodology ensures that:

- Results of the measurements are comparable and repeatable
- The measured energy consumption has a strict relation with the real energy consumption in everyday hospital use. Such information is important for hospitals and clinics to understand the real running cost of CT to plan and allocate correctly their budget
- The procedure does not involve disproportionate costs or resources
- The measurement results allow the determination of all the information that could be considered relevant for the SRI target setting process but could also be useful for CT users.

The methodology is available for download at COCIR website.

4.6.2. THE MEASUREMENT METHODOLOGY IN BRIEF

The SRI SC decided to use as functional unit a typical day of functioning of the CT scanner in hospital environment. The SRI SC determined as a realistic use scenario representing a typical day in the hospital 20 examinations over 12 hours.

To determine representative CT clinical procedures, the study “European Guidance on Estimating Population Doses from Medical X-Ray Procedures”, published by Directorate-General for Energy and Transport in 2008, is used here to determine the distribution of procedure types. From this report the defined procedure distribution used within is:

Examination	Distribution	Examinations per day
CT head	42,9%	9
CT chest	15,9%	3
CT spine	16,9%	3
CT abdomen	24,2%	5

Second, within each procedure type, the specific scan parameters representing each exam type have been chosen to harmonize across manufacturers to general values:

The 12 hours have been subdivided in 20 intervals of 35 minutes each (as shown in table 15).

Table 15: Allocation of body regions scans during the 12 hours working time

	1	2	3	4	5	6	7	8	9	10	11	12	13	14	15	16	17	18	19	20		
Type of examination	H	A	H	T	H	A	S	H	T	H	A	S	H	T	H	A	S	H	A	H		Total
Duration (min)	10	35	35	35	35	35	35	35	35	35	35	35	35	35	35	35	35	35	35	35	10	720

Trial executions of testing showed a further simplification of the test procedure is possible by approximating the range of protocols by only the Abdomen scan. Table 16 shows the allocation

of time during the working hours.

Table 16: Allocation of abdomen scans during the 12 hours working time

		1	2	3	4	5	6	7	8	9	10	11	12	13	14	15	16	17	18	19	20			
Type of examination		A	A	A	A	A	A	A	A	A	A	A	A	A	A	A	A	A	A	A	A	A		Total
Duration (min)		10	35	35	35	35	35	35	35	35	35	35	35	35	35	35	35	35	35	35	35	35	10	720

$$E_{scan} = 20 \times E_{Abdomen}$$

Each interval of 35 minutes includes (see figure 13) time in Scan mode, typical of each CT scanner and the remaining time in Idle mode. The scan interval, as shown in figure 13, is the time between the scan prescription and the moment the power usage is back to Idle mode.

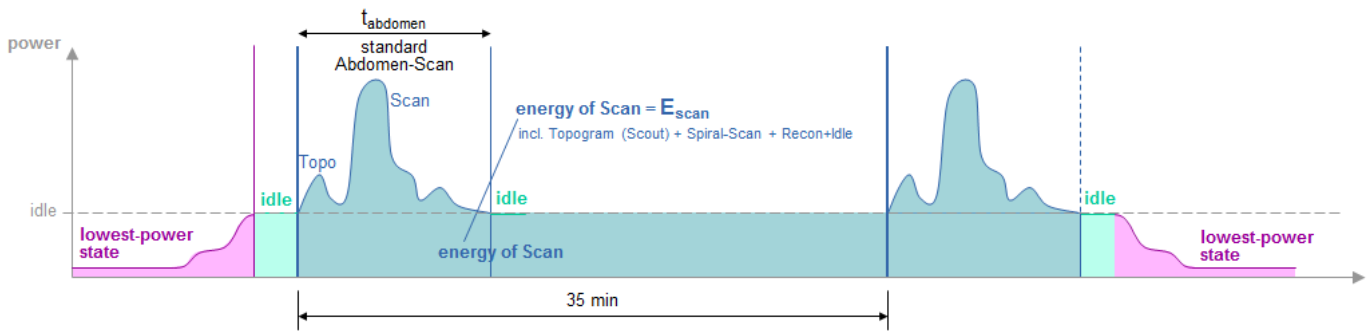

Figure 13: Representation of power draw of a CT scanner during LowPower, Idle and Scan mode

The energy consumption of CT can be calculated by summing the measured energy consumption in each mode, where applicable, to a given use scenario:

$$\text{Energy use} = E_{off} + E_{idle} + n \times E_{scan} + E_{low}$$

4.6.3. ASPECTS OF THE METHODOLOGY TO BE IMPROVED

The measurement methodology is a powerful tool that allows the measurement of energy consumption based on a use scenario that is very close to everyday practice.

Nonetheless the methodology still has some weak points that the SRI Steering Committee is committed to improve in the coming years.

Benefit for patients

In its current form the methodology takes marginally into account the benefits for patients. companies are working to provide better technologies with improved functions, able to provide better comfort and benefits for patients such as:

- Image quality and resolution
- Integration with other technologies
- Shorter exam durations
- Noise insulation systems
- Alternatives to the use of contrast agents
- Dose reduction

Most of those options require higher energy use. In particular the reduction of the dose is one of the most researched issues at the moment. The reduction of the x-ray dose involves more



powerful and sophisticated reconstruction capabilities, which translates into higher computational power and therefore higher energy consumption. An increase in the average energy consumption for CT due to the increased functionality and/or dose reduction is not recorded by the methodology.

4.7. ENERGY CONSUMPTION

SRI participating companies measured most of the models placed on the market in 2012. The average energy usages are reported in table 17 for the 4 functioning modes.

Table 17⁴²: Average CT energy consumption in different modes in case the CT is switched to LowPower mode overnight.

Mode	Typical time in mode per day	Average energy consumption per day	Estimate of % energy in use phase ⁴³
	Hours	kWh/d	
Off mode	0	0	0%
LowPower mode	12	12,2	25%
Idle mode	10,8	31,1	62%
Scan mode	1,2	6,1	13%
Total		50	

The daily energy consumption⁴⁴ depends on which mode is selected for 12h night time.

Table 18: Average CT energy consumption in different scenarios.

Scenario	Description	Average energy consumption per day
		kWh/d
Off	The CT is switched to Off mode during the 12h night time. No energy consumption.	37
LowPower	The CT is switched to LowPower mode during the 12h night time	50
Idle	The CT works in Idle mode during the 12h night time	72

According to the modularization defined in chapter I.V, the energy consumption can be allocated in the different modules and modes as indicated in figure 14.

⁴² Values taken from the PE International Study : Computed Tomography (CT) - Study on the potential for environmental improvement by the aspect of energy efficiency – Page 23

⁴³ Percentages are calculated against a scenario assuming the scanner working in the corresponding mode for the 12h night time. For this reason percentages cannot be summed to obtain 100%

⁴⁴ Values taken from the PE International Study : Computed Tomography (CT) - Study on the potential for environmental improvement by the aspect of energy efficiency – Page 29

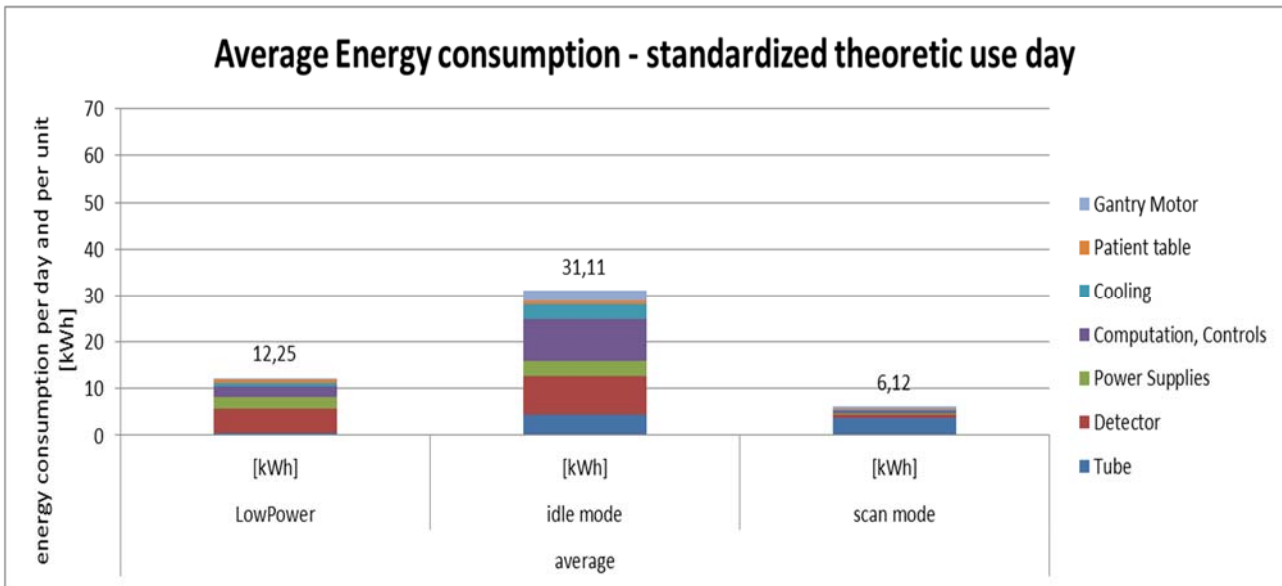

Figure 14: Energy consumption over a typical day in LowPower, Idle and Scan mode allocated to the different modules of the CT scanner⁴⁵.

4.8. REDUCTION OF X-RAY DOSE – COCIR VOLUNTARY COMMITMENT WITH HERCA

Media reports, the public and governmental authorities have placed ionizing radiation exposure and dose reduction measures in medical imaging high on the public health agenda. This increases the awareness among the various stakeholders, such as clinical professionals, equipment manufacturers, regulators, hospital managers, patients, etc.

New requirements and the implementation of future workflow concepts on dose management and dose reporting are currently being considered around the world. Since February 2010, regular discussions are taking place between COCIR and the Heads of European Radiation Competent Authorities (HERCA) requesting our industry to commit in reducing radiation dose for CT equipment. As the developers of sophisticated scanners, CT manufacturers acknowledge their unique role in the process to help optimize patient CT dose in the health care setting.

A dedicated COCIR Task Force was created to respond to HERCA's request and a COCIR CT manufacturers' voluntary commitment was released in May 2011.

The aim of this commitment is to further the initiatives of improving dose reporting, promoting transparency in dose efficacy, continuing reduction of medical exposures, and provision of specific training curricula.

The manufacturers agree to complete the voluntary commitments outlined within and provide yearly updates on:

1. Characterization of CT Systems Standardized Benchmarking
2. Implementation of dose reduction measures in CT
3. Dose management and reporting
4. Provision of specific training curricula

COCIR CT manufacturers have been developing and providing dose reduction features on CT systems for many years, and this trend continues today:

⁴⁵ PE International: "Computer Tomography: Study on the potential for environmental improvement by the aspect of energy efficiency", page 23.



- Patient Protocol Selection Guidance
- Automatic Tube Current Modulation (ATCM) and X-ray Initiation
- Precise X-ray Field shaping
- Dose Efficient Design
- Dose reporting and Awareness
- Training Opportunities
- Pediatric Protocols
- Dedicated Infant Imaging Mode
- Advanced Tube and Collimator Design
- Dose Efficient Detection
- Dose Display and Recording
- Optimized Image Reconstruction

Some of the above mentioned technological solution could bring to higher energy consumption while trying to reduce dose. Their mutual feedbacks and interactions on energy usage are extremely hard to forecast. For this reason, companies could not provide an estimation of the evolution of energy usage for the next years, but an increase in idle energy is most likely.

All the documentation related to the COCIR Voluntary Commitment with HERCA is available on the COCIR website.

4.9. USER BEHAVIOUR

Given the energy consumption data in the two scenarios in the previous chapter, the SRI SC looked carefully into a fundamental issue influencing energy consumption patterns: user behavior.

The analysis has been performed on two levels:

1. Company field data
2. Literature⁴⁶

CT scanners used in emergency care settings are rarely turned Off or to Low Power mode during night hours, but are kept in idle mode for rapid imaging to meet the needs of critical care. The SRI SC confirmed that many scanners used in other radiology settings are left in an idle mode during overnight hours. They are rarely turned Off or to LowPower mode, in fact are typically powered down only for maintenance or software reboot.

The analysis confirmed that around 90% of the scans are performed between 8.00 am and 8.00 pm (12h working time per day), but also that up to 70% of the scanners are not switched to Off/LowPower mode overnight. On the average, the remaining 30% is switched off only 50% of the time.

Considering the reduced energy consumption over 12 hours of the Off mode (0 kWh) or LowPower mode (12,3 kWh) compared to idle mode (34,6 kWh), a correct user behavior could allow to save from 12,23 to 34,6 kWh per day just by switching the CT scanner from idle. This value represents up to 48% of the energy used daily.

⁴⁶ IEEE Explore: [Energy consumption of VA hospital CT scans / Study \(Denmark\) - Energy Efficiency in Hospitals and Laboratories](#)

4.10. IMPROVEMENT POTENTIAL

The PE International study⁴⁷ on the improvement potentials regarding the energy consumption for CT shows that:

1. **No improvements possible in scan mode:** considering the short duration of scans and the priority given to the reduction of the dose for patients, no improvements in the energy consumption are achievable. As a consequence of improvements in other modes, a small increase in scan energy is possible.
2. **Limited improvements in idle mode:** Considering the short periods of idle mode in between scans and the need for the user to have the scanner always ready to scan for the next examination, reduction of energy use during idle mode is hardly possible. Switched off components would require time to be reactivated thus hampering availability of the scanner in a very short time.
3. **Significant improvement potential in LowPower mode:** LowPower mode offers the greatest potential for improvement. In LowPower mode modules are active to provide a fast reactivation of the CT scanner to idle mode.

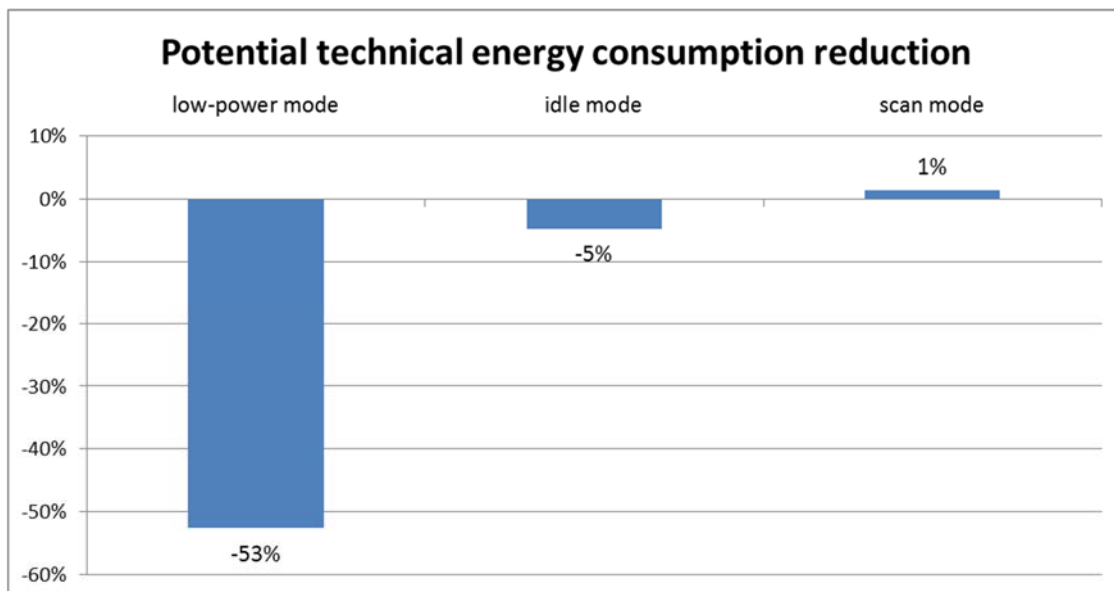

Figure 15: Maximum improvement potentials of CT technology per mode

It is important to note that the reported improvements are the maximum improvement potentials, also taking into consideration technologies that are not yet available today (BnyAT). Therefore any final target would be necessarily lower. It is also important to consider that the LowPower mode accounts for just a 24,5% of the total daily energy consumption and therefore the 53% improvement even if possible, will end up in a 13% reduction.

The analysis of user behavior showed that about 70% of CT scanners are never switched to Off/LowPower during the 12h night time and the remaining 30% only 50% of the time on the average. This means that, unless user behavior can be influenced, any reduction of the device energy usage in LowPower mode may have a limited net effect for users (around 1,9%), since the LowPower mode is rarely used.

⁴⁷ PE International: "Computer Tomography: Study on the potential for environmental improvement by the aspect of energy efficiency", page 31. Available at www.cocir.org



4.11. APPLICATION OF SRIV3 METHODOLOGY TO CT

4.11.1. SRI METHODOLOGY FOR ECODESIGN TARGET SETTING IN BRIEF

The fourth step of the SRI methodology sets the ecodesign target as the market average performance of the selected aspect, to be achieved in a time equal to the specific innovation cycle.

The SC Secretariat collects from companies the measurements of all CT models and, on the basis of the reduction potentials determined by the PE INTERNATIONAL study on CT, calculates the target scenarios⁴⁸:

- Baseline today
- Business as usual (BAU)
- Best not yet available technology (BnyAT)
- Beyond Business as usual.

Based on these scenarios, the SRI SC decides on a feasible industry reduction target. Before it is integrated into company design targets, the industry target is proposed to the European Commission for discussion.

The results of this step are two types of targets:

- Industry target: that's the target that all the participating companies have to achieve as the average of the market and is equal (unless a different decision is justified) to the value provided in the Beyond as usual scenario. This target is the target against which the success of the initiative has to be assessed.
- Individual company targets: Those are improvement targets that each company can derive from the reported scenarios. A company absolute target is equal to the average value provided by the BnYAT scenario. Such targets are used as an internal tool to keep track of improvements, to decide corrective actions and to ensure companies' commitment.

4.11.2. SCOPE

The SRI Steering Committee decided to exclude certain specific CT models from the SRI methodology. In particular:

- 256 slices (or higher) scanners
- Dual source scanners

Dual source scanners are produced only by one Company today. Those are top level scanners equipped with two x-ray tubes. Both dual source and 256 (or higher) slice scanners represents high-end models, with increased functionality and top performances which involve higher energy consumption. Therefore the potential for improvement is extremely limited and should be investigated with extreme care to avoid that possible technical solution to reduce the energy consumption could compromise or reduce the performances.

4.11.3. FUNCTIONAL UNIT

The functional unit is the reference ensuring the comparability of power consumption of different products and their developments over time.

As identified in the CT energy measurement methodology, the functional unit is a typical daily usage in hospital environment.

⁴⁸ For additional information on scenarios refer to SRIV3 documentation, Appendix V: www.cocir.org



4.11.4. INNOVATION CYCLE

The innovation cycle is defined as the time needed to develop new or enhanced products and place them on the market. For medical devices it could vary from 3 years to 7, depending on the complexity of the innovation being brought to market.

The below listed activities for CT requires:

- Research and development - 1 year
- Realization, Verification and Validation - 3 years
- Regulatory Approvals - 1 year

The innovation cycle for CT therefore corresponds to 5 years.

4.11.5. SETTING THE ECODESIGN TARGET

The analysis and studies performed by the SRI SC and PE International revealed so far two important aspects of CT technology that have to be taken into account:

1. The potential for improvement is limited: improvements can be achieved mainly in LowPower mode, which contribution to the daily energy consumption is limited (around 26% of daily energy usage) and rarely used (about 70% of all scanners are not switched to LowPower during 12h night time).
2. Ongoing activities and voluntary commitment of COCIR companies for the reduction of the x-ray dose are going to affect the energy consumption in scan and idle mode. While it is difficult to forecast the interaction of technical solutions and their effects on energy consumption, it is very likely that the energy consumption in idle will increase due to higher computation power required by more powerful iterative image reconstruction engines and longer computational time.
3. The energy savings allowed by the Off mode or LowPower mode, already implemented on CT scanners today, are not achieved due to user behavior. Any improvement achieved with technical solutions in such modes would not be used anyway.

4.11.6. INFLUENCING USER BEHAVIOUR

As shown by the PE International study, already existing Off and LowPower modes could ensure an energy saving between 30% and 45% of daily energy consumption. Nonetheless such options are not used by users.

Any technical solution to reduce the energy consumption could only improve the usage in LowPower mode and hardly in Idle mode.

In particular during working hours CT scanners work in Idle mode in-between scans, therefore for a quite short period. Reducing energy consumption in such periods would be complex as reactivation to idle mode could take quite some time which could be non-compatible with clinical needs.

The SRI SC concluded that the greatest reduction in energy usage can be achieved by influencing the users' behavior through proper education and information about the possible energy savings related to an environmental friendly use.

Energy savings achievable by improving the use of LowPower mode can amount up to 8,8 MWh per year. Figure 16 shows the savings on a daily basis.

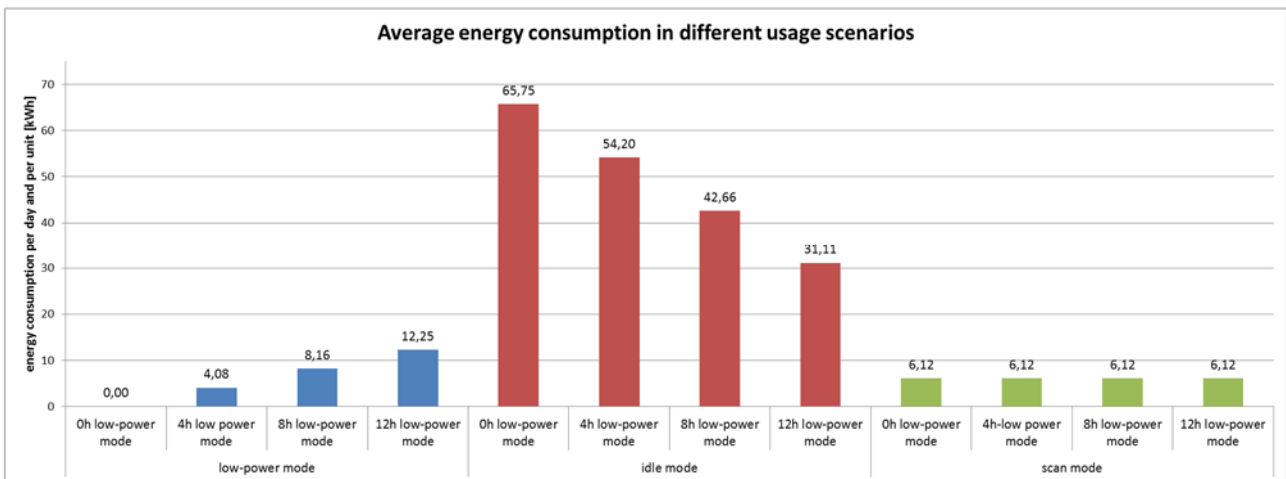

Figure 16: Energy consumption scenarios based on time spent by the scanner in LowPower mode during the 12h night time⁴⁹

Figure 17 shows the total daily energy consumption resulting from different duration of LowPower mode. The right column shows the energy usage in case the scanner is switched to Off mode during the 12 h night period.

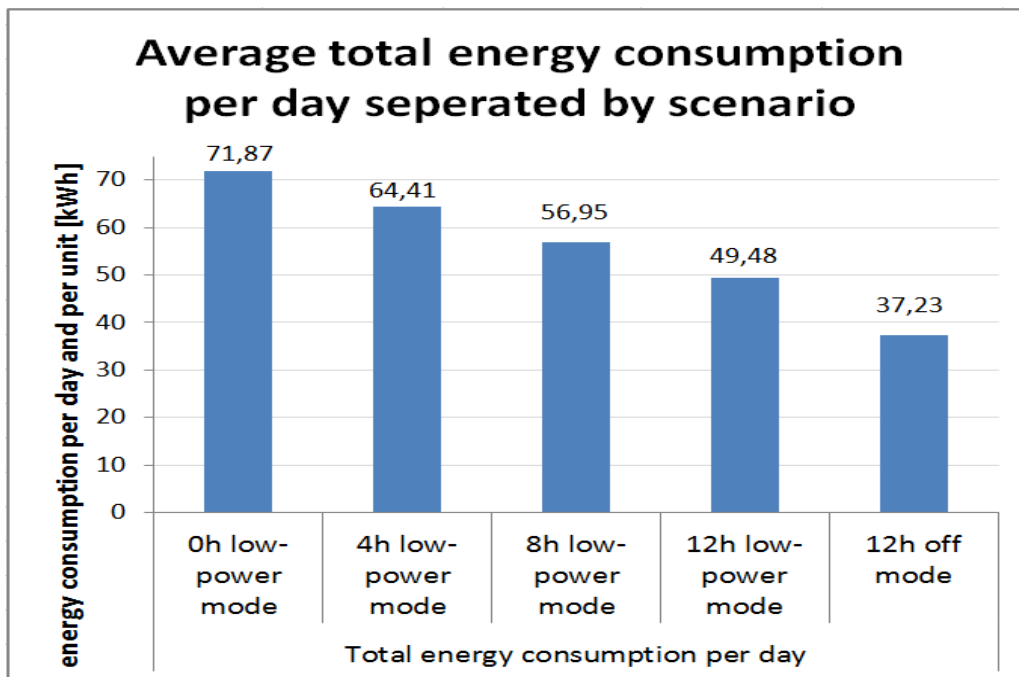

Figure 17: Energy savings achievable by using LowPower and Off mode during 12h night time⁵⁰

Ecodesign goals decided by the SRI SC to achieve energy savings by influencing user behavior towards an environmentally friendly use practice are reported in Chapter 6.

⁴⁹ PE International: "Computer Tomography: Study on the potential for environmental improvement by the aspect of energy efficiency", page 29.

⁵⁰ PE International: "Computer Tomography: Study on the potential for environmental improvement by the aspect of energy efficiency", page 30.

APPENDIX V

5. X-RAY IMAGING EQUIPMENT

5.1. GENERAL DESCRIPTION OF X-RAY IMAGING EQUIPMENT

Radiography is an imaging technique that uses X-rays to view the internal structure of a non-uniformly composed and opaque object such as the human body. To create the image, a heterogeneous beam of X-rays is produced by an X-ray generator and is projected toward the patient's body. A certain amount of X-ray is absorbed by the body, which is dependent on the particular density and composition of the area. The X-rays that pass through are captured by a detector (either photographic film or a digital detector). The detector can then provide a superimposed 2D representation of all the body's internal structures.

X-ray technologies

X-ray imaging comprises a lot of different applications for specific body parts or clinical needs. X-ray can be divided into two main groups: Fluoroscopy and Radiology

Fluoroscopy is an imaging technique that uses X-rays to obtain real-time moving images of the internal structures of a patient through the use of a fluoroscope. In its simplest form, a fluoroscope consists of an X-ray source and fluorescent screen between which a patient is placed. However, modern fluoroscopes couple the screen to an X-ray image intensifier and CCD video camera allowing the images to be recorded and played on a monitor. The x-ray generation may last for several minutes at very low intensity.

Some forms of radiography include:

- Angiography
- Fluoroscopy
- Surgery

Radiography is used for fast, highly penetrating images, and is usually used in areas with high bone content. X-rays are generated for milliseconds at higher intensity.

Some forms of radiography include:

- Radiography
- Gen&Uro
- Mammo





Figure 18: Different models of x-ray devices

Digital detectors and image intensifiers

Traditional X-ray devices use a film sensitive to x-rays to produce the images. Other technologies have been introduced to allow the image to be digitally acquired or to be projected on a screen and recorded on a media.

Image intensifiers: a specific component of an x-ray imaging system, which allows low intensity x-rays to be converted to a visible light output. The device contains a low absorbency/scatter input window, typically aluminum, input fluorescent screen, photocathode, electron optics, output fluorescent screen and output window. These parts are all mounted in a high vacuum environment within glass or more recently, metal/ceramic. It allows the viewer to more easily see the structure of the object being imaged than past fluorescent screens. This device was originally introduced in 1948.

Viewing of the output was via mirrors and optical systems until the adaption of television systems in the 1960s. Additionally, the output was able to be captured on systems with a 100mm cut film camera using pulsed outputs from an x-ray tube similar to a normal radiographic exposure; Today CCD cameras are used.

Digital detectors: Digital detectors are an alternative to Image Intensifiers. The detector, roughly the same size of the image to be captured due to impracticability of focusing x-rays, converts x-rays into a charge that can be read and used to build the image. The most common technology is based on an indirect X-ray conversion process, using cesium iodide scintillators. It offers considerable advantages in radiography, angiography and fluoroscopy. The other method employs a direct converter such as selenium which is particularly suitable for mammography. Both flat detector technologies are based on amorphous silicon active pixel matrices.

Digital detectors facilitate the clinical workflow, ensure improved image quality which can help in reducing the dose at the expense of some energy as, to work correctly, they have to be kept at specific steady state temperature and therefore the x-ray device generally cannot be turned off. Digital detectors are also more fragile and are not suited for portable x-ray devices.

Battery powered x-ray equipment

Some x-ray equipment is powered by battery. The usage patterns and the energy consumption of such equipment are very different from the ones of mains powered x-rays. The SRI SC analysed only mains powered devices but discussions will continue in 2014 to include this specific category both in the measurement methodology and the ecodesign goal.



5.2. MARKET DATA

The COCIR companies⁵¹ in the X-ray sector represent a total turnover in Europe of ✓843⁵² million euros in 2015.

Table 19: X-ray - EU⁵³ market data

Modality	2013 Market Value	2014 Market Value	2015 Market Value
X-Ray	✓766 M€	✓770 M€	✓843 M€

Market coverage

The X-ray modality comprises a lot of different categories. Unlike other imaging equipment in the scope of the SRI there is a big number of companies manufacturing x-ray devices. The actual SRI participating companies cover around 92% of the market for angiography systems, but less than 52% for all the remaining categories.

Nonetheless COCIR believes that the best results can be achieved by developing concepts and methodologies that can encompass all x-ray categories. For this reason, the measurement methodology has been simplified to ensure it can be used to measure the energy consumption of any model, from huge angiography or interventional systems, to small mobile devices.

5.3. MEASUREMENT METHODOLOGY

The SRI Steering Committee started in 2013 to develop a methodology to measure the energy consumption of X-ray equipment, as there are no available standards that could be used.

The methodology ensures that:

- Results of the measurements are comparable and repeatable
- The measured energy consumption has a strict relation with the real energy consumption in everyday hospital use. Such information is important for hospitals and clinics to understand the real running cost of X-ray to plan and allocate correctly their budget
- The procedure does not involve disproportionate costs or resources
- The measurement results allow the determination of all the information that could be considered relevant for the SRI target setting process but could also be useful for X-ray users.

The methodology is available for download at COCIR website.

5.4. THE MEASUREMENT METHODOLOGY IN BRIEF

The SRI SC decided to use as functional unit a typical day of functioning of the X-ray scanner in hospital environment. According to expert judgment the time spent in scan mode is in the order of 'seconds per day' and therefore the energy consumption in scan mode is around 4% of the daily energy usage for the most energy intensive categories such as interventional or angiography x-ray.

The energy consumption in scan mode is also defined by many parameters and variables which should be defined for each specific x-ray category. The required complexity is not justified by the limited energy consumption during scans.

⁵¹ The total turnover of COCIR Members in the x-ray sector is used here to avoid disclosing sensitive data each time a company joins the initiative, due to the large number of companies in this modality (only 6 in COCIR SRI).

⁵² COCIR Imaging Market Statistics source (SHARE).

⁵³ Countries included: Estonia, Latvia, Lithuania, Bosnia, Bulgaria, Croatia, Czech Republic, Hungary, Poland, Romania, Serbia, Slovakia, Slovenia, Ukraine, Portugal, Spain, Denmark, Finland, Norway, Sweden, Ireland, UK, Austria, Belgium, France, Germany, Greece, Italy, Netherlands, Switzerland, Albania, Macedonia.



Therefore, the Steering Committee decided that the measurement methodology should not take into account scan mode, which would introduce a new layer of complexity to account for less than a 4% daily energy consumption.

Functioning Modes

Four modes have been defined for X-ray equipment.

Off mode: The system is shut down, AC mains off, according to the user manual. The system consumes no energy.

Low-power: The system functions into the minimum energy consumption state that the user can select according to the user manual.

Ready-to-scan: A state of the system when fully powered and ready to acquire the image.

Scan mode: A state of the system during scans. This mode includes tube rotor rotation, x-ray generation and generation of image.

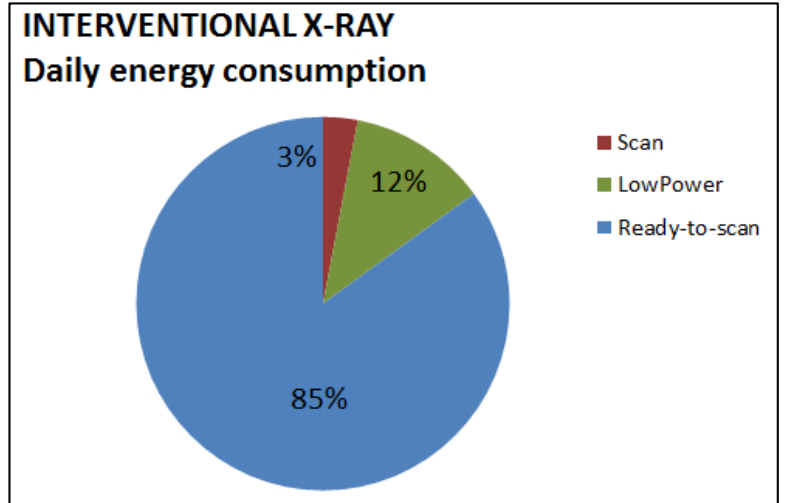

The power consumption of X-ray in the four modes during a typical day is represented in figure 20.

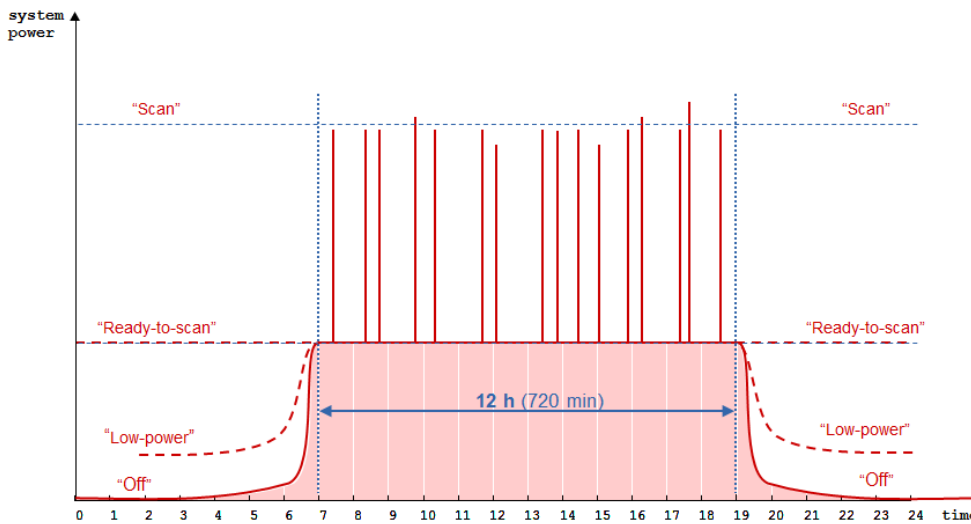

Figure 20: Exemplary power consumption of MRI

The daily energy consumption is calculated as the sum of the energy usage in the different modes. It has to be noted that certain technologies cannot be switched to off-mode (or it is highly recommended not to).



5.5. MODULARIZATION

The most important power consuming modules of the entire x-ray system have been identified.

Tube and generator chain:	X-ray tube and all the power supplies used to power the tube and all connected devices.
Detector/Image intensifier:	Device reading the x-ray radiation and converting it into digital signal/image
Power distribution unit and other power supplies	Subsystems required for electrical energy conversion and distribution
Computation, Controls:	Units dedicated to the reconstruction and elaboration of the image, the control of the x-ray system.
Cooling:	A collection of subsystems required for thermal management of x-ray components, in particular the x-ray tube.
Patient table:	Patient table with electric movement controls

5.6. ENERGY CONSUMPTION

X-ray devices are quite simple compared to the modalities analyzed so far by the SRI (MRI and CT) and the energy consumption is lower.

Considering the great variety of categories of x-rays, and the SRI Members market coverage, values are reported for complex x-rays such as angiography and interventional systems. For other categories lower power and energy consumption can be expected.

Table 20⁵⁴: Average x-ray energy consumption in different modes in case the x-ray is switched to LowPower mode overnight.

Mode	Typical time in mode per day	Average power consumption	Average energy consumption per day
	Hours	kW	kWh/d
LowPower	12	0,15	1,8
Ready-to-scan	12	0,6	7,3
Scan mode	Minutes	1,4	-

The COCIR SRI focuses on angiography and interventional x-ray systems. The energy consumption for other x-ray devices is lower. For mammography systems, for instance, the power consumption in lowpower mode is lower than 0,1 kW.

5.7. IMPROVEMENT POTENTIAL

X-ray technology is not very different in principles from Computed Tomography. X-ray equipment are simpler than CT as the x-ray tube is not rotated by a gantry around the patient and the image is directly acquired without the need of complex engines for the reconstruction of a 3D image. CT scanners are also able to acquire hundreds of slices in one single examination.

⁵⁴ Values taken from the PE International Study : "Computed Tomography (CT) - Study on the potential for environmental improvement by the aspect of energy efficiency", (2013) – Page 23

The COCIR expert group on x-ray analysed the x-ray technology and realized that the improvement potentials for modules are not different from the ones identified for CT equipment. Therefore the 26% improvement potential identified in LowPower mode can be reasonably assumed to be too high for X-ray keeping in mind that:

- X-ray equipment without digital detectors does not need to use energy for maintaining the steady state temperature, therefore the potential for improvement is lower.
- In 2014 it is expected only 15% of installed x-ray devices are equipped with digital detectors, and only high end stationary models. 45% of models sold in 2013/2014 are expected to be equipped with image intensifiers.
- The number of modules which are active is lower in x-ray, therefore there are lower chances to reduce the energy usage by switching of or to low power unnecessary modules.

As for CT, most x-ray devices are not switched off or to lowpower mode during night hours and therefore possible savings in such modes are not going to achieve any practical result.

5.8. USER BEHAVIOR

Considering the great variety of X-ray categories and different uses (from mobile c-arc to stationary interventional systems), it is impossible to identify a general user behaviour. Nonetheless considering the findings of previous projects it can be expected that most users do not profit of the low power or switch off functions of x-ray devices.

The same conclusion are contained in the study of the Danish Energy Saving Trust "Energy Efficiency in Hospitals and Laboratories" where the energy consumption of x-ray and user behavior have been investigated:

*"Energy savings can be achieved compared with current modes of operation. At present, in those hospitals involved in the project, X-ray equipment **is always left in standby mode outside working hours** because the medical staff considers that the reliability of the equipment will be impaired by frequent ON/OFF operation".*

The following measurement table shows that over a 6 day measurement the x-ray device is never switched of maintaining a power absorption between 0,6 and 0,7 kW.

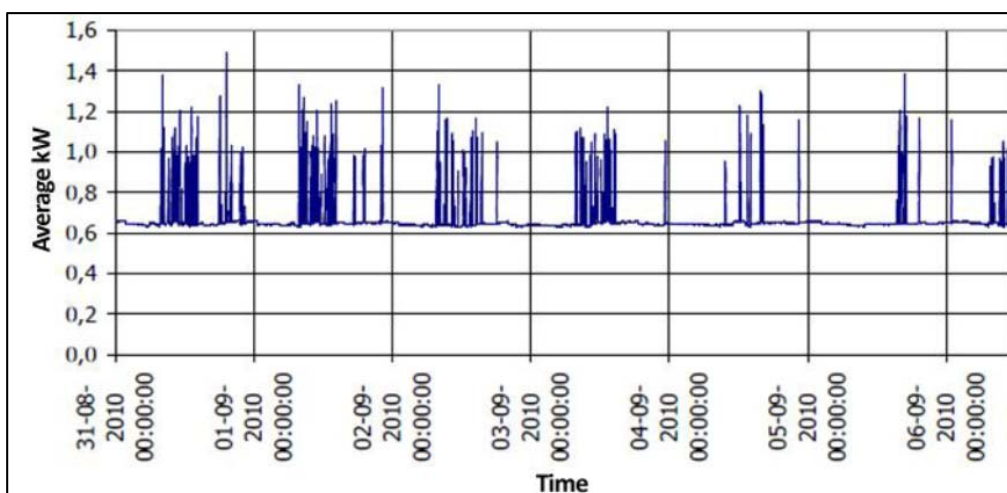

Figure 21: Power measurement of an x-ray device over a week in a Danish hospital

The study also concludes that:



“Secondly, despite the fact that most Danish hospitals have an impressive track record when it comes to implementing energy efficiency projects, the research showed that there is a significant, and additional energy saving potential. **Many of the energy efficiencies are linked to working practice associated with the way in which medical equipment and laboratory equipment is operated.**”

5.9. INFLUENCING USER BEHAVIOUR

The SRI SC concluded that the greatest reduction in energy usage can be achieved by influencing the users’ behavior through proper education and information about the possible energy savings related to an environmental friendly use.

Already existing Off and LowPower modes could ensure an energy saving between 50,5% and 64,3% of daily energy consumption (see figure 22). Nonetheless such options are not widely used by users.

The use of Off mode during the night hours and weekend can save up to 3,45 MWh per year on average per equipment.

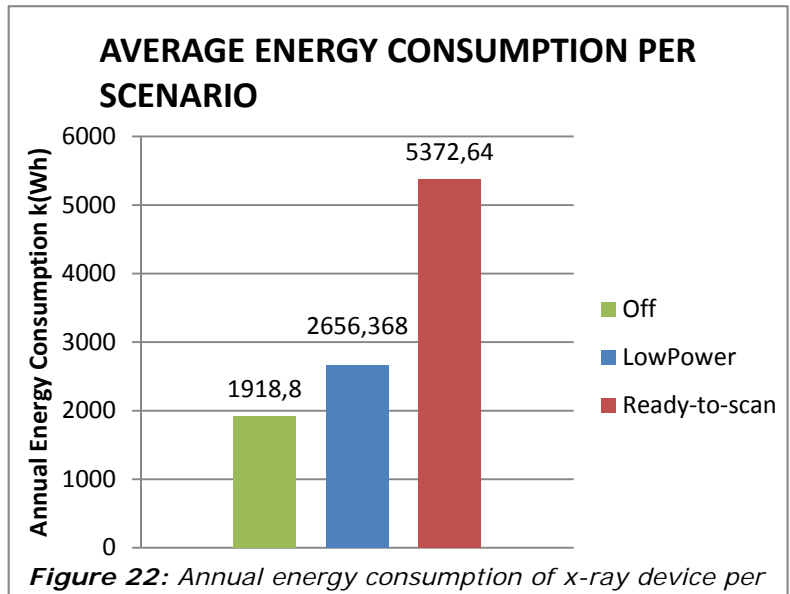

Figure 22: Annual energy consumption of x-ray device per scenario

APPENDIX VI

6. NUCLEAR IMAGING

6.1. GENERAL DESCRIPTION OF NUCLEAR IMAGING EQUIPMENT

In nuclear medicine imaging, the image is generated by using detectors (gamma cameras) which reads the gamma radiation emitted by a radio-isotope introduced in the body of the patient (orally or intravenous), whose properties bind it to certain types of tissues. This process is unlike a diagnostic X-ray, where external radiation is passed through the body to form an image.

Technologies

There are several techniques of nuclear imaging. This report focuses on positron emission tomography (PET) and single photon emission tomography (SPECT)

SPECT is very similar to conventional nuclear medicine planar imaging using a gamma camera but it is able to provide 3D information. Instead of just "taking a picture" of anatomical structures, a SPECT scan monitors level of biological activity at each place in the 3-D region analyzed. Emissions from the radionuclide indicate amounts of blood flow in the capillaries of the imaged regions.

To acquire SPECT images, the gamma camera is rotated around the patient. Projections are acquired at defined points during the rotation, typically every 3–6 degrees. In most cases, a full 360-degree rotation is used to obtain an optimal reconstruction. The time taken to obtain each projection is also variable, but 15–20 seconds is typical. This gives a total scan time of 15–20 minutes. Multi-headed gamma cameras can provide accelerated acquisition. For example, a dual-headed camera can be used with heads spaced 180 degrees apart, allowing two projections to be acquired simultaneously, with each head requiring 180 degrees of rotation. Triple-head cameras with 120-degree spacing are also used.



Fig. 23: SPECT scanner

PET detects the gamma ray emission generated by a positron emitted by the decay of the radionuclide in the body of the patient. The positron travels in tissue for a short distance to a point where it interacts with an electron, annihilating each other producing a pair of annihilation (gamma) photons moving in opposite directions. These are detected when they reach a scintillator in the scanning device, creating a burst of light which is detected by photomultiplier tubes or silicon avalanche photodiodes (Si APD).

The technique depends on simultaneous or coincident detection of the pair of photons moving in opposite directions. Photons that do not arrive in temporal "pairs" (i.e. within a timing-window of a few nanoseconds) are ignored.

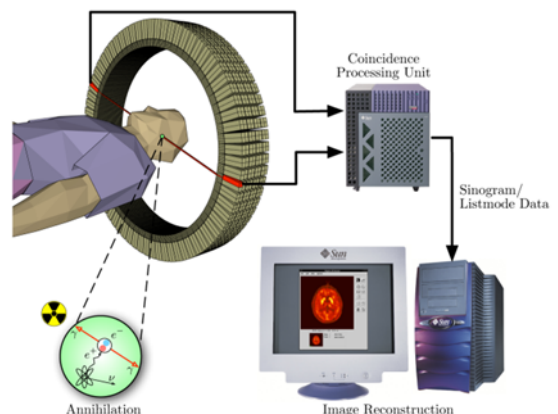

Fig. 24: Scheme of PET scanner by Jens Maus

Combined Technologies

Nuclear imaging, combined with MRI and CT technologies are getting widespread for the additional benefits of adding precision of anatomic localization to functional imaging.

PET/SPECT-CT is a medical imaging technique combining a PET/SPECT scanner and a CT scanner, so that images acquired from both devices can be taken sequentially, in the same session, and combined into a single superposed (co-registered) image. Thus, functional imaging obtained by PET/SPECT, which depicts the spatial distribution of metabolic or biochemical activity in the body can be more precisely aligned or correlated with anatomic imaging obtained by CT scanning. Two- and three-dimensional image reconstruction may be rendered as a function of a common software and control system. The first PET-CT was installed in 1998.

PET/SPECT-MRI is a medical imaging technology that combines MRI soft tissue morphological imaging and PET/SPECT functional imaging. The technology combines the structural and functional characterization of tissue provided by MRI with the extreme sensitivity of PET/SPECT imaging of metabolism and tracking of uniquely labeled cell types or cell receptors. The first PET-MRI scanner was installed in 2010.



Fig. 25: from left to right, two models of PET-CT and one model of PET-MRI

6.2. MARKET DATA

The ✓3⁵⁵ companies participating in the SRI for the nuclear imaging sector represent a total turnover in Europe of ✓194⁵⁶ million euros in 2015, covering between 98% and 100% of the EU market.

In 2013 and 2014 no PET scanners have been placed on the market as the technology has been replaced by PET-CT or PET-MRI.

In 2013, 116 SPECT scanners were sold. While SPECT combined technologies are well established, there is still some market demand for SPECT scanners.

6.3. FUNCTIONING MODES

6.3.1. PET

In PET scanners, the PET gantry is always fully powered. Maintaining steady temperature of the scintillator crystals is fundamental as it would require otherwise a long time for the device to be ready to perform a scan. Unlike in MRI or Ct there is no emission of x-ray or RF during scan, therefore the energy usage is quite stable during the day.

Off mode: The system functions into the minimum energy consumption state that the user can select according to the user manual. As the PET gantry is expected to be running 24/7/365

⁵⁵ GE Healthcare, , Philips Healthcare, Siemens Healthcare

⁵⁶ COCIR Imaging Market Statistics source (SHARE).



the system cannot be shut down to no-energy usage. Computers and accessories are turned off.

Ready-to-scan/Scan mode: All components are running. The power state/consumption is the same whether a scan is occurring or not.

6.3.2. SPECT

SPECT scanners can be turned off to zero energy consumption but they are normally left in low-power modes overnight as the detectors have to be maintained at a specific temperature. Warming up the scanner from Off mode takes a long time.

Off: The system is shut down, according to the user manual. The system consumes no energy.

Low-power: The system functions into the minimum energy consumption state that the user can select according to the user manual. No motion.

Scan mode: This mode represents the state of the system during scans with typical clinical motion and detectors acquiring data.

6.4. ENERGY CONSUMPTION

In both PET and SPECT systems, the energy consumption is quite stable as there is virtually no difference between scan mode and other modes. The main difference is the energy state of accessories such as computers and monitors which may be switched off during night time and week-ends.

6.5. PET: POWER USAGE AND DAILY ENERGY CONSUMPTION

Table 21 reports the power usage of the PET part of a PET-CT system and an average use scenario. The PET part absorbs around 4.3 kW in Off mode and a 16-20% in ready-to-scan/scan mode. This increase is due to the dedicated computers, up-to 5 computers with high output power supplies to handle multiple CPUs and GPUs. The daily energy consumption can be estimated in around 109 kWh/d.

Table 21: power usage of the PET part of a PET-CT scanner

PET power usage	Off Mode	Ready-to-scan	Scan
Power Consumption (kW)	4.3	4,9	4,9
Daily usage (hours)	14	7	3

6.6. SPECT: POWER USAGE AND DAILY ENERGY CONSUMPTION

Table 22 reports the power usage of a SPECT scanner and an average use scenario. The SPECT absorbs 0,61 kW in Low-power mode and 0,63 in Scan-mode. The daily energy usage can be estimated around 15 kWh/d.

Table 22: power usage of a SPECT scanner not turned to off mode during the night

SPECT : power usage	Off	Low-power	Scan
Power Consumption (kW)	0	0,61	0,63
Daily usage (hours)	0	16	8

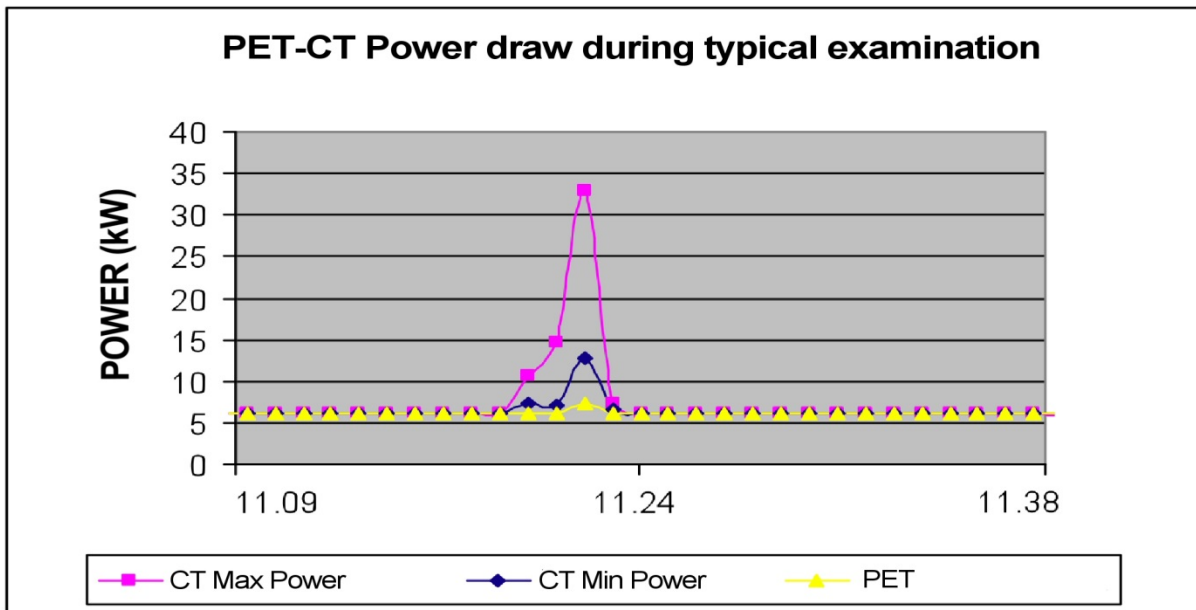

Fig. 26: CT-PET power draw during a typical examination: IGEEOP Project (2009): "Indagine Sui Consumi Energetici Delle Grandi Apparecchiature Ospedaliere"



APPENDIX VII

7. METHODOLOGY FOR ASSESSING THE CIRCULARITY OF THE MEDICAL IMAGING DEVICES BUSINESS MODEL

In 2015, at the 4th Annual Forum on the COCIR SRI, COCIR presented its conclusions about reuse and refurbishment activities being one of the most significant contributions to reducing environmental impact of medical imaging devices.

In 2015/2016 COCIR worked on a first methodology to estimate the circularity of the economic model. Such methodology aims at defining an index which can be later used for monitoring improvements. Additional work is needed to shape the methodology in such a way that the calculation of the index is based on data which can be easily obtained by companies with good approximation.

7.1. BENEFITS OF REFURBISHMENT

As already presented in many publications, refurbishment and repair activities brings significant benefits to the environment, patients and economy:

- Saves energy and CO₂: by avoiding the production of new equipment, refurbishment contributes to save energy and CO₂. DITTA⁵⁷ estimates that around 30 MWh can be saved for each ton of refurbished medical devices.
- Prevents waste generation: DITTA estimates⁵⁸ that in 2012 around 16.400 tons of used medical devices have been prevented from becoming waste, instead being shipped worldwide for refurbishment and repair.
- Saves resources and raw materials: medical devices make use of many scarce raw materials
- Contributes strongly to increased access to healthcare:
 - 20%-30% reduced cost for healthcare providers, while ensuring safety and high clinical performance.
 - Improvement of the age profile of installed equipment allowing hospitals with limited budget to substitute their old equipment.
 - Increase in quality of healthcare and safety for patients due to the reduction of the obsolescence of installed equipment.
- Contributes to safety of used medical devices which are restored to a point of safety and effectiveness comparable to when the device was new.
- Contributes to growth and economy. The refurbishment of medical equipment accounted for a global revenue of approximately 480 million euros in 2012⁵⁹.

7.2. FROM LINEAR TO CIRCULAR: ROLE OF REFURBISHMENT

The European Union is aiming at moving the current "linear" model towards a circular one by means of modification of current legislation and introduction of new one.

But moving from a linear model to a circular one is not a linear process. While it is clear that a perfect circular economy cannot be achieved, the degree of success depends on the implementation of all possible measures to prevent waste generation and use of resources from the design to the end of life phase, and to boost recycling of waste. The system complexity therefore increases non-linearly with the number of feedback loops which bring resources back to use diverting them from landfill, which is considered the end of the cycle.

⁵⁷ DITTA: is the global voice for diagnostic imaging, radiation therapy, healthcare IT, electromedical and radiopharmaceutical manufacturers

⁵⁸ Based on ad hoc DITTA internal survey on transboundary movements of used medical devices

⁵⁹ DITTA Market Statistics

The best way to design a circular economy model for a specific industrial sector is to start from a linear one and to increase complexity of the model step by step adding loops which helps increasing resource efficiency level.

7.2.1. PERFECT LINEAR ECONOMY

A perfect linear economy⁶⁰ is defined as a model where resources are used to make products which are discarded after the use phase without any recovery of materials.



7.2.2. REAL LINEAR ECONOMY

In reality recycling of valuable fractions such as steel and copper has been in place for many years in almost any industrial sector. Nonetheless, in a linear economy, most of the waste generated is disposed of in landfill rather than being captured for recycling. This is represented by the red arrow leaving the "EOL" phase and ending directly in "LANDFILL"

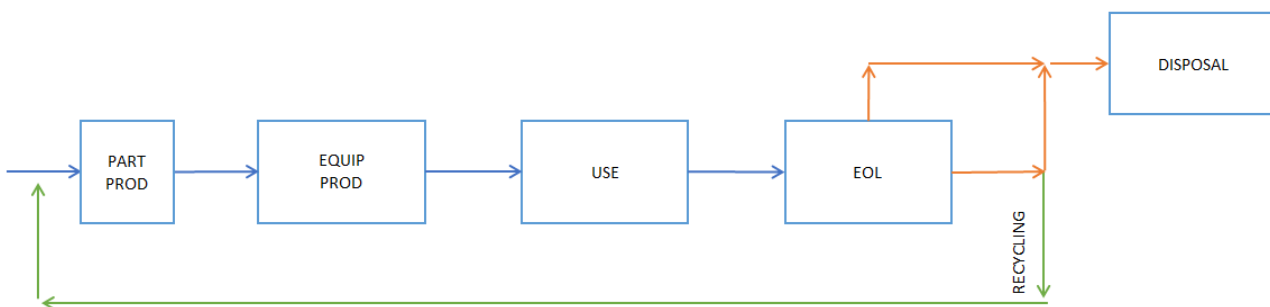

7.2.3. RECYCLING ECONOMY

With the introduction in EU of collective schemes for waste package (Waste Packaging Directive) and in 2005 of Extended Producer Responsibility schemes on electric and electronic products (WEEE Directive) and automotive (ELV Directive) the EU economy moved, for those sectors, towards a more recycling economy model.

In this model most of the products are collected at the "EOL" phase and sent to recycling. Activities such as "preparation for reuse" can be in place but they will always be marginal for two reasons:

- Economy of the process
- Legislative barriers about reuse of recovered components in particular the chemical policy

Reuse may be an established activity but its role is anyway marginal. Reuse is driven by the economy of the process but reused products have to deal with consumer acceptance and the low cost of new products. Reuse activities are limited by legal barriers as the legislator has no attention to them.

⁶⁰ PROD: production; EOL: end of life

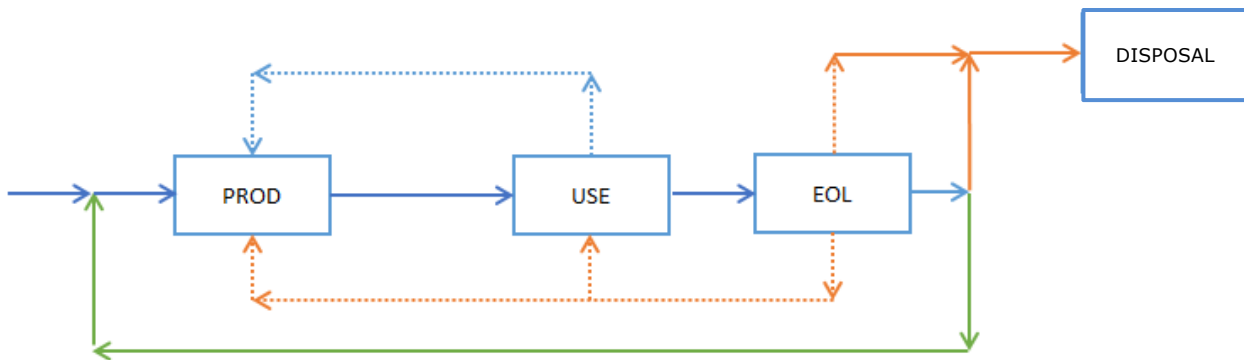

The limits of this model are the recycling rate and the reuse of the recycled fractions:

- Technical limits to recycling rate
- Economic limits to recycling rate
- Economic value of recycled materials compared to virgin materials
- Purity/quality of recycled material
- Down-cycling rate

The down-cycling rate has to be seriously considered when defining the circularity of a specific industrial sector. When considering the economy in its entirety, down-cycling diverts resources from the landfill to other industrial sectors. Eventually such resources will have to be landfilled, thus leaving the cycle. In a specific industrial sector down-cycling has to be considered as the resources sent to recycling may not re-enter the cycle and new resources should be used despite the recycling rate.

The EC package on circular economy aims at increasing the way waste is managed, pushing towards a high level of collection and recycling. At the same time, the EC package also intends to promote real reuse of the recycled/recovered fractions by boosting the market for recovered materials.

Those initiatives are more in line with the just examined "recycling economy model".

7.2.4. SIMPLE CIRCULAR ECONOMY: INTRODUCING REUSE

The only way to move beyond the limits of a recycling economy is to prevent resources to become waste (a percentage is always destined to landfill). Reuse is a form of life time extension which allows resources to stay in the cycle longer before being sent to recycling. As long as resources are used, less new resources are needed to fill manufacturing and use needs. Simple reuse "as is", without any additional processing, does not really extend the technical life time of a product. This practice simply prevents products to be discarded before they reach the end of their life, but also involves problems related with performances, reliability and safety. As such, simple reuse is going to be irrelevant.

Refurbishment is a specific form of reuse which restores performances, quality, safety and reliability to a state comparable to when the product/part was new. Refurbishment significantly extend the life time of products and parts solving the limits related to performances and safety.

In the model for the medical imaging sector "Preparation for reuse" is not considered as it is not a feasible option for medical devices. In fact, only parts or equipment which cannot be further refurbished and reused are discarded and sent to the "EOL" stage.

7.2.5. THE MODEL

This model includes three forms of reuse:

1. Reuse of used medical devices: used devices are refurbished and then sold.
2. Reuse of parts generated during refurbishment, repair or maintenance: such parts are refurbished and used for refurbishment, repair and maintenance.
3. Reuse of parts in manufacturing: reused parts are used in the manufacturing of new equipment.

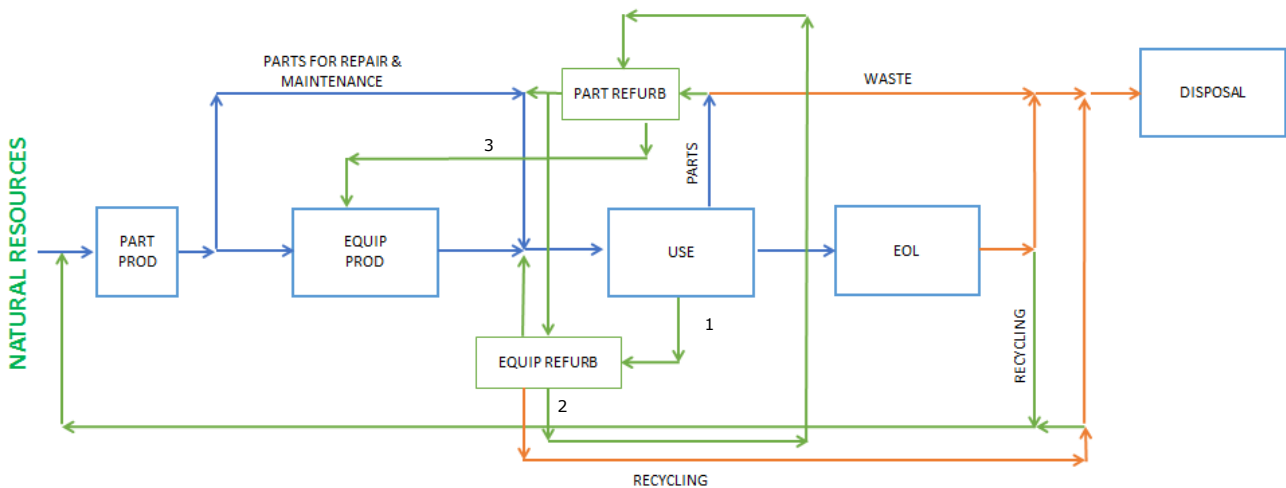

In the medical device sector experts estimate that up to 80% of certain modalities can be reused through refurbishment thus reducing significantly the quantity of material sent to "EOL" and then recycling.

REUSE OF PARTS FOR MANUFACTURING NEW PRODUCTS

Route 3, reusing parts in new products, could bring significant benefits in term of resource efficiency. This is indeed one of the best possible reuse activities. While reused and refurbished equipment are destined to a specific market with intrinsic limits, the reuse of parts into new equipment has unlimited potential.

The principle is already embedded in the EU legislation and international standards:

- **RoHS Directive⁶¹:** article 4.5 exempts recovered spare parts from RoHS when used to manufacture new equipment, under certain conditions.
- **ISO/IEC 24700:2004:** it specifies product characteristics for use in an original equipment manufacturer's declaration of conformity to demonstrate that a marketed product that contains reused components performs equivalent to new, meeting equivalent to new component specifications and performance criteria, and continues to meet all the safety and environmental criteria required by responsibly built products.
- **IEC IEC 62309:2004:** Introduces the concept to check the reliability and functionality of reused parts and their usage within new products. Also provides information and criteria about the tests/analysis required for products containing such reused parts, which are declared "qualified-as-good-as-new" relative to the designed life of the product. The purpose of this standard is to ensure by tests and analysis that the reliability and functionality of a new product containing reused parts is comparable to a product with only new parts.

⁶¹ Directive 2011/65/EU of 8 June 2011 – L174/88



7.2.6. PERFECT CIRCULAR ECONOMY

In a perfect circular economy the use of natural resources is reduced to the minimum, just to supply the cycle with the resources which cannot be recovered by recycling due to physical or economic factors. The flowchart is the same but the input of resources is further reduced.

7.3. RESOURCE EFFICIENCY OF ECONOMY MODELS

The difference in the listed models, from the linear to the circular one, lies mostly in the amount of natural resources used per year. By defining the efficiency of the different operations such as recycling, refurbishment, reuse, etc and supposing the amount of products placed on the market equal to 100% it is possible to define a mass balance of the model and then to measure, at least in theory, the circularity of the model.

It is also important to assume that the installed base will not change over the year so a static system can be built. The variation in the installed base can be taken into account in a dynamic system but that would increase the complexity for no reason at this stage.

The COCIR SRI Steering Committee decided to define the Circularity Index as:

$$C.I. = \frac{\text{(Tons of reused equipment)}}{\text{(Tons of sold equipment)}}$$

- Perfect circular economy - C.I. = 1
- Perfect linear economy - C.I. = 0

In the following examples approximations based on expert judgment are used to quantify the different models for didactic reasons (refer to chapter 7.4 for additional information on how to calculate the index). The object is to show how reuse contributes to circularity to a great extent. No measurements have yet been taken by the SRI SC, therefore the final results may be quite different.

7.3.1. LINEAR ECONOMY

The models are now customized on the real model of the medical imaging sector. Resources are used to manufacture new equipment, parts and components which are used to maintain and repair the installed base. This distinction is important when dealing with a circular economy model.

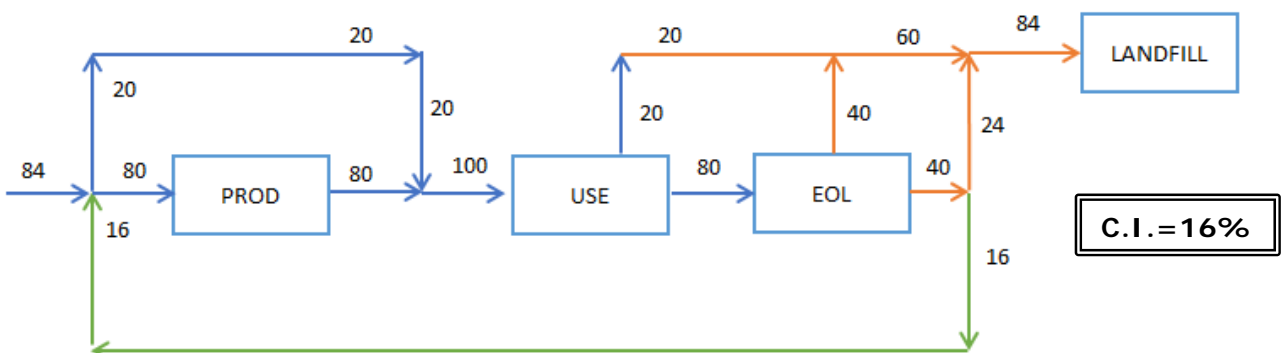

$$C.I. = \frac{16}{100} = 16\%$$



7.3.2. REAL RECYCLING ECONOMY

In a real recycling economy most of the generated waste is collected and the recycling efficiency is as high as possible (technically and economically). The recycling efficiency also includes the rate of effective reuse of recycled material in the same loop (down-cycled resources are not considered).

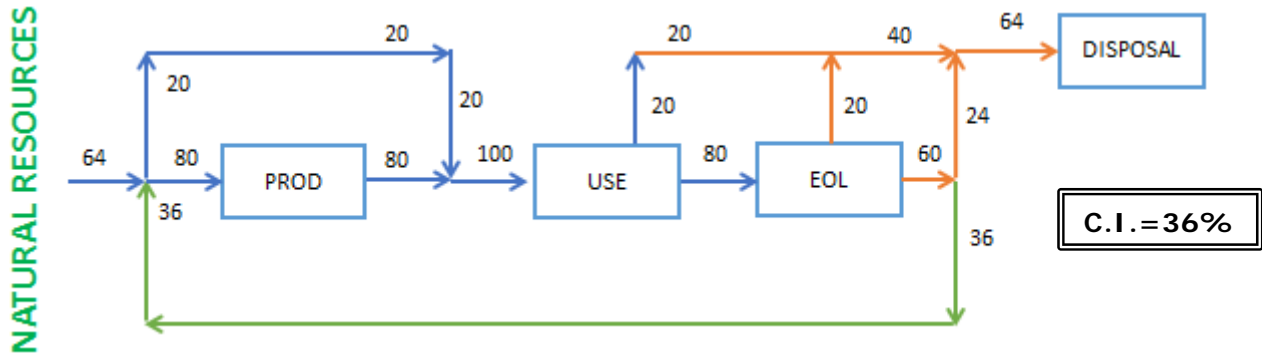

$$C.I. = \frac{36}{100} = 36\%$$

7.3.3. PERFECT RECYCLING ECONOMY

In a perfect recycling economy almost 100% of the generated waste is collected and the recycling efficiency is as high as possible (technically and economically). The recycling efficiency also includes the rate of effective reuse of recycled material in the same loop (down-cycled resources are not considered).

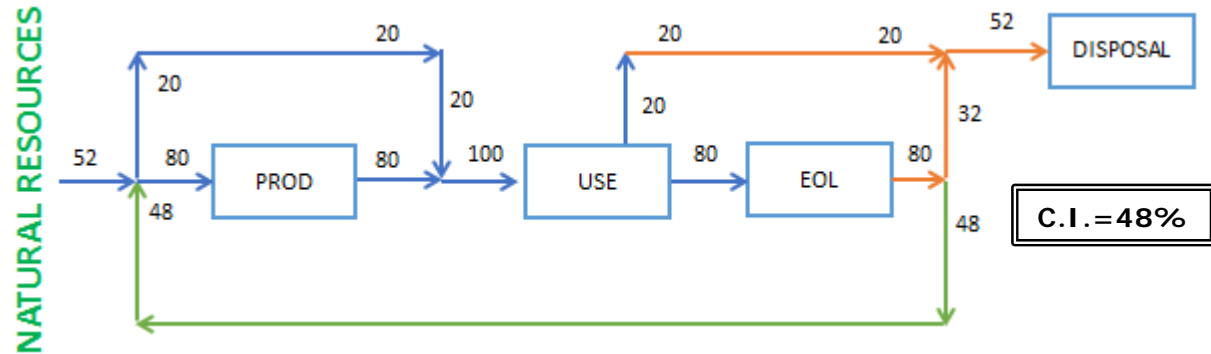

$$C.I. = \frac{48}{100} = 48\%$$



7.3.4. INTRODUCING REFURBISHMENT

To move beyond the limits of recycling, reuse has to be implemented. In the medical imaging sector the form reuse of whole equipment which ensures safety and performances is called refurbishment to differentiate from the simple reuse “as is”, or second hand market. Medical devices are bought back from owner by manufacturers or third parties to be refurbished and re-sold on the market.

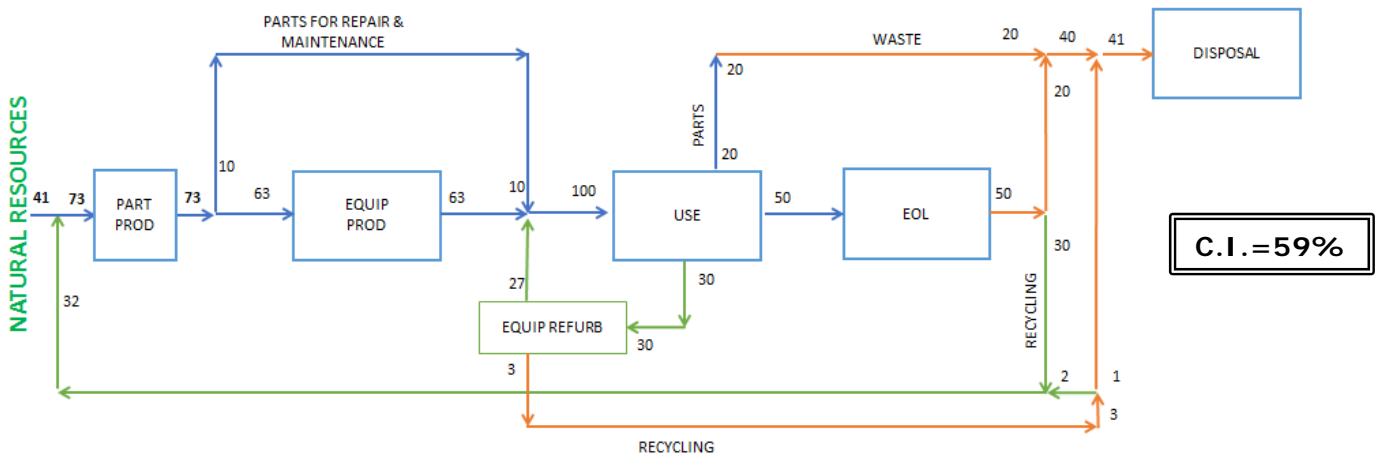

$$C.I. = \frac{32 + 27}{100} = 59\%$$

7.3.5. INTRODUCING REFURBISHMENT OF PARTS

In the medical imaging sector reuse of parts plays a fundamental role in ensuring:

- Servicing of the installed base
- Cost containment
- Prompt availability of parts for repair and servicing

Parts are sourced from different origins:

- Products under refurbishment
- Repair or maintenance activities

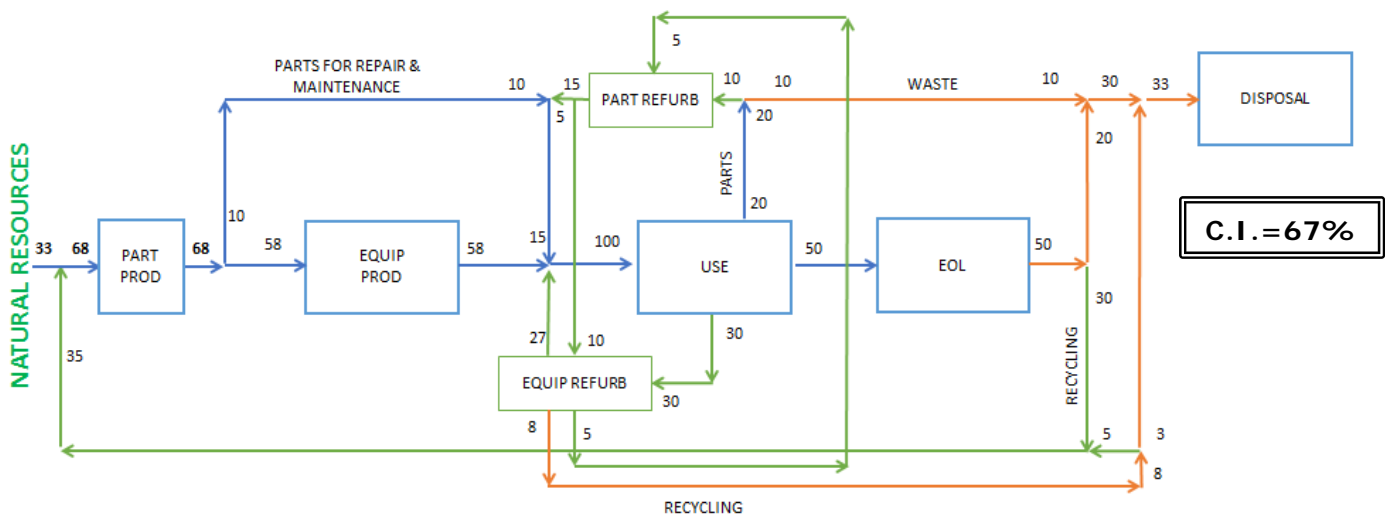

$$C.I. = \frac{35 + 27 + 5}{100} = 67\%$$



7.3.6. FULL SCALE CIRCULAR ECONOMY

A further and last step to improve the efficiency of the circular economy model is to increase the reuse rate of parts by using such recovered parts in the manufacturing on new equipment. This practice has been in place for a long time in the sector for specific high value/long life components, such as CT detectors, x-ray tubes or MRI magnets.

In a full scale circular economy model parts and equipment can be freely recovered, refurbished and reused whenever necessary without any unnecessary limitation provided by national, EU or international legislation.

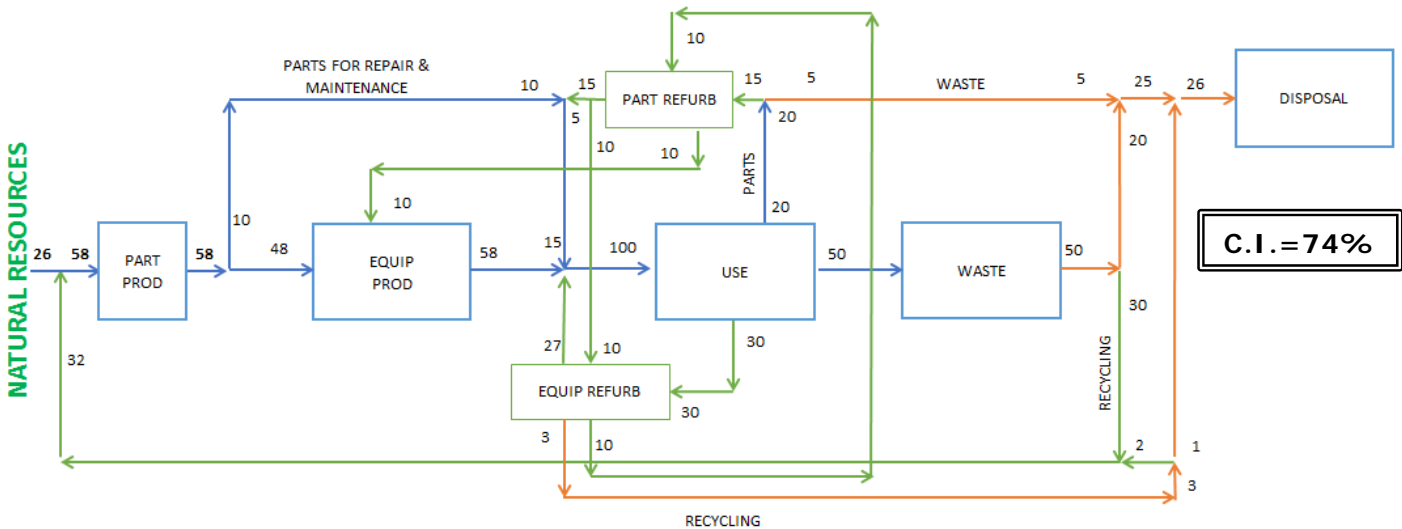

$$C.I. = \frac{32 + 27 + 5 + 10}{100} = 74\%$$

7.4. MEASURING THE MEDICAL IMAGING SECTOR

In the full scale circular economy model the C.I. index is calculated as the sum of:

$$C.I. = \frac{RM + PM + RE + RP}{POM} * 100$$

Where:

- RM: Mass of recycled materials
- PM: Mass of parts re-used in manufacturing of new equipment
- RE: Mass of refurbished equipment
- RP: Mass of reused parts in repair and maintenance
- POM: Mass of new products and parts placed on the market

Or

$$C.I. = \frac{POM - LF}{POM} * 100$$



Where:

LF: Mass sent to disposal

RM: Mass of recycled materials

The mass of recycled materials can be estimated knowing the total amount of waste sent to proper management and using an average value for the recycling rate.

As companies in the medical imaging sector uses individual schemes to fulfil the obligations of the WEEE Directive, the recycling rate can be sourced from recyclers of medical devices.

In reality the calculation could be more accurate but counting only the fractions which is really reused (metals) and excluding the fraction which is down-cycled (e.g. plastic)

$$RM = (W * \eta)$$

Where

η : recycling rate

RP: Mass of reused parts in repair and maintenance

While it may be possible to estimate the number of parts used in repair and maintenance of the installed base it is more difficult to know the mass as the weight of parts is not used and due to the heterogeneity, an average weight is meaningless.

On the other end it may be assumed that for each recovered part used to repair an installed medical device, an equivalent part is discarded as waste or sent to refurbishment.

For parts discarded as waste, the weight should be known. The complexity is represented by the numerous service providers who normally take care of installed equipment and which, sometimes are not related to the OEM.

For parts shipped for refurbishment the weight of the shipments should be known for each shipment.

PM: Total mass of reused parts in production of new equipment

This data should be known to companies. In particular, after July 2014, this activity is mostly forbidden and therefore close to zero, with the exception of RoHS compliant spare parts:

- No RoHS substances or
- Applications covered by exemptions

RE: Total mass of refurbished equipment placed on the market

This data can be collected direct from companies. COCIR Market SHARE system already collects the sales volume in units. By defining an average weight an estimation of the mass can be possible.

7.5. DEVELOPMENT OF THE METHODOLOGY

During 2016 and 2017 the SRI SC will be committed to:

- Adapting the circular economy model used to describe the medical imaging sector to real industry practice.
- Develop assumptions and simplifications in order to allow companies to extract the required data.

Given the significant differences between modalities in scope of the SRI, a different model may be developed for each modality and the index calculated.

Once data are available for all modalities a global index for the sector represented by COCIR may be defined. This final index qualifying the medical imaging sector is probably going to be a good estimation given the high market coverage of COCIR.



A methodology to extrapolate/interpolate data for modalities where the COCIR market coverage is lower may be developed as well.

Improvement potential

COCIR will look in 2016 and 2017 into the different processes: waste generation rate and reuse rate to determine the improvement potential of such activities.

Legal barriers will be analyzed to evaluate their impact in terms of costs and increased use of resources.



APPENDIX VIII

7. EPD - ENVIRONMENTAL PRODUCT DECLARATION

The format developed by participating companies enables the individual member companies to systematically use the Environmental Product Declaration to communicate the most significant aspect(s) that the SRI sets for each targeted modality. Additional information on the EPD is available in the SRI Methodology Appendix 5.

MINIMUM EPD REQUIREMENT including SRI targets and aspects		
SRI CONTENT - mandatory		
SRI	"Product xxx is part of the SRI Ecodesign Initiative for Medical Equipment to reduce the total energy consumption of units sold by xx % until Year xxxx."	
	Energy use according to specific scenarios and operating conditions	kWh ⁶²
Strongly recommended:		
	Energy related	Unit
	CO ₂ footprint in use phase according to specific scenarios and operating conditions	kg
	Environmentally relevant content/weight information	Unit
	Product	
	Weight of product	kg
	Type and number of batteries	list
	Relevant materials content - e.g. list RoHS, REACH SVHC, BoMcheck...	list
	Packaging	
	Weight	kg
	composition	list
	recyclable material content	%
	Additional Ecologically relevant information	Unit
	End of life aspects	
	refurbishing program available for the system	yes/no
	re-use of components program available for the system components	yes/no
	cleaning disinfection needed yes/no, if yes which chemicals	yes/no
	Information for user and recyclers (includes WEEE recycling passport info)	describe
Optional		
	Energy related	Unit
	Patient throughput for standard operation or energy per analysis	pat/day
	Waste during normal use (hazardous /non-hazardous/predefined categories?)	kg
	Emissions during normal use (hazardous /non-hazardous?)	kg
	Additional Ecologically relevant information	Unit
	heat dissipation output - operating, stand-by, cooling,	kWh
	start up time	min
	Additional relevant information	Unit
	Power and material saving options (e.g. to previous product)	describe

⁶² This unit depends on the targeted environmental aspect. In this case it is "energy use" and thus "kWh". It might also be a material, e.g. "copper" and thus "kg".



Additional End of Life aspects	
material recycling possibilities, Cradle to Cradle	describe
ease of dismantling	describe
Life cycle impact - company specific -	
% impact per LCA phase (e.g.10% materials, 80% use; specify LCIA method)	%/ describe
Noise, radiation, vibration, EMC	dB(A)
Other Health and Safety related information	Unit
voluntary actions (product and/ or company specific)	describe
CSR related	describe
Environmental education	describe



APPENDIX VIII

8. INDEPENDENT PRACTITIONER'S LIMITED ASSURANCE REPORT

To the European Coordination Committee of the Radiological, Electromedical and Healthcare IT Industry ("COCIR"), the SRI Steering Committee Secretariat of the Self-Regulatory Initiative ("SRI") for Medical Imaging Equipment under the Ecodesign Directive, Brussels.

We have been engaged to perform a limited assurance engagement on selected data marked with ✓ in the Status Report of the SRI for Medical Imaging Equipment under the Ecodesign Directive (hereafter the "SRI Status Report"), Brussels, for the year 2015 in the context of the reporting requirements of the SRI.

Management's Responsibility

The SRI Steering Committee Secretariat of the SRI is responsible for the preparation and presentation of the SRI Status Report in accordance with the six step methodology as stated in the SRI V1 (for ultrasound imaging equipment) and SRI V3 (for MRI, CT and future modalities) (hereafter the "SRI six step methodology"):

- Step 1: Gather baseline data
- Step 2: Prioritization and selection of next modality
- Step 3: Identification of significant environmental aspect(s) for the selected modality
- Step 4: Derive environmental targets and objectives for the selected modality
- Step 5: Implementation into company processes
- Step 6: Monitoring and reporting

and for the selection of the information to be assessed.

This responsibility includes the selection and application of appropriate methods to prepare the SRI Status Report as well as the use of assumptions and estimates for individual SRI disclosures which are reasonable in the circumstances. Furthermore, the responsibility includes designing, implementing and maintaining systems and processes relevant for the preparation of the SRI Status Report, which is free of material misstatements due to intentional or unintentional errors.

Audit Firm's Independence and Quality Control

We have complied with the German professional provisions regarding independence as well as other ethical requirements.

The audit firm applies the national legal requirements and professional standards – in particular the Professional Code for German Public Auditors and German Chartered Auditors ("Berufssatzung für Wirtschaftsprüfer und vereidigte Buchprüfer": "BS WP/vBP") as well as the joint opinion of the Wirtschaftsprüferkammer (Chamber of German Public Auditors; WPK) and the Institut der Wirtschaftsprüfer (Institute of Public Auditors in Germany; IDW): Requirements to quality control for audit firms ("Gemeinsamen Stellungnahme der WPK und des IDW: Anforderungen an die Qualitätssicherung in der Wirtschaftsprüferpraxis": "VO 1/2006") – and accordingly maintains a comprehensive system of quality control including documented policies and procedures regarding compliance with ethical requirements, professional standards and applicable legal and regulatory requirements.



Practitioner's Responsibility

Our responsibility is to express a limited assurance conclusion on the data marked with ✓ in the SRI Status Report based on our work performed.

Within the scope of our engagement we did not perform a substantive audit on external sources of information or expert opinions, used to prepare and referred to in the SRI Status Report.

We conducted our work in accordance with the International Standard on Assurance Engagements (ISAE) 3000 (Revised): "Assurance Engagements other than Audits or Reviews of Historical Financial Information" published by IAASB. This Standard requires that we plan and perform the assurance engagement to obtain limited assurance whether any matters have come to our attention that cause us to believe that the data marked with ✓ in the SRI Status Report has not been prepared, in all material respects, in accordance with the SRI six step methodology.

In a limited assurance engagement, the evidence-gathering procedures are more limited than for a reasonable assurance engagement and therefore significantly less assurance is obtained than in a reasonable assurance engagement. The procedures selected depend on the practitioner's judgement. This includes the assessment of the risks of material misstatements of the data marked with ✓ in the SRI Status Report with regard to the above mentioned SRI six step methodology.

Within the scope of our work we performed amongst others the following procedures:

- Inquiries of personnel at the SRI Steering Committee Secretariat (COCIR) responsible for the preparation of the SRI Status Report regarding the process to prepare the report and the underlying internal control system;
- Inspection and sample testing of the systems and process documentation for collection, analysis and aggregation of the selected data;
- Recalculation of the aggregation and KPIs calculation for selected data;
- Analytical procedures on selected data;
- Inspection of documents regarding the description of the SRI six step methodology (SRI V3) and its application to MRI as detailed in 'Magnetic resonance Equipment (MRI) - Study on the potential for environmental improvement by the aspect of energy efficiency' and 'Magnetic Resonance – Measurement of energy consumption'.

Conclusion

Based on our limited assurance engagement, nothing has come to our attention that causes us to believe that the data marked with ✓ in the SRI Status Report of the SRI for Medical Imaging Equipment under the Ecodesign Directive for the year 2015 has not been prepared, in all material respects, in accordance with the SRI six step methodology.

Emphasis of Matter – Recommendations

Without qualifying our conclusion above, we make the following recommendations for the further development of the reporting of the Self-Regulatory Initiative for Medical Imaging Equipment under the Ecodesign Directive:

- Develop a policy to require the SRI members to submit assurance certificates for annual sales data and data on the environmental aspects in scope for each modality;
- Further improvement of effectiveness and documentation of controls.



Restriction on Use and Distribution

We issue this report on the basis of the engagement agreed with COCIR. The review has been performed for purposes of the SRI for Medical Imaging Equipment under the Ecodesign Directive and is solely intended to inform SRI for Medical Imaging Equipment under the Ecodesign Directive about the results of the review. The report is not intended for any third parties to base any (financial) decision thereon. We do not assume any responsibility towards third parties.

Munich, 8 September 2016

PricewaterhouseCoopers
Aktiengesellschaft
Wirtschaftsprüfungsgesellschaft

Hendrik Fink
Wirtschaftsprüfer
(German Public Auditor)

ppa. Dr. Patrick Albrecht

General Engagement Terms

for

Wirtschaftsprüfer and Wirtschaftsprüfungsgesellschaften

[German Public Auditors and Public Audit Firms]
as of January 1, 2002

This is an English translation of the German text, which is the sole authoritative version

1. Scope

(1) These engagement terms are applicable to contracts between Wirtschaftsprüfer [German Public Auditors] or Wirtschaftsprüfungsgesellschaften [German Public Audit Firms] (hereinafter collectively referred to as the "Wirtschaftsprüfer") and their clients for audits, consulting and other engagements to the extent that something else has not been expressly agreed to in writing or is not compulsory due to legal requirements.

(2) If, in an individual case, as an exception contractual relations have also been established between the Wirtschaftsprüfer and persons other than the client, the provisions of No. 9 below also apply to such third parties.

2. Scope and performance of the engagement

(1) Subject of the Wirtschaftsprüfer's engagement is the performance of agreed services – not a particular economic result. The engagement is performed in accordance with the Grundsätze ordnungsmäßiger Berufsausübung [Standards of Proper Professional Conduct]. The Wirtschaftsprüfer is entitled to use qualified persons to conduct the engagement.

(2) The application of foreign law requires – except for financial attestation engagements – an express written agreement.

(3) The engagement does not extend – to the extent it is not directed thereto – to an examination of the issue of whether the requirements of tax law or special regulations, such as, for example, laws on price controls, laws limiting competition and Bewirtschaftungsrecht [laws controlling certain aspects of specific business operations] were observed; the same applies to the determination as to whether subsidies, allowances or other benefits may be claimed. The performance of an engagement encompasses auditing procedures aimed at the detection of the defalcation of books and records and other irregularities only if during the conduct of audits grounds therefor arise or if this has been expressly agreed to in writing.

(4) If the legal position changes subsequent to the issuance of the final professional statement, the Wirtschaftsprüfer is not obliged to inform the client of changes or any consequences resulting therefrom.

3. The client's duty to inform

(1) The client must ensure that the Wirtschaftsprüfer – even without his special request – is provided, on a timely basis, with all supporting documents and records required for and is informed of all events and circumstances which may be significant to the performance of the engagement. This also applies to those supporting documents and records, events and circumstances which first become known during the Wirtschaftsprüfer's work.

(2) Upon the Wirtschaftsprüfer's request, the client must confirm in a written statement drafted by the Wirtschaftsprüfer that the supporting documents and records and the information and explanations provided are complete.

4. Ensuring independence

The client guarantees to refrain from everything which may endanger the independence of the Wirtschaftsprüfer's staff. This particularly applies to offers of employment and offers to undertake engagements on one's own account.

5. Reporting and verbal information

If the Wirtschaftsprüfer is required to present the results of his work in writing, only that written presentation is authoritative. For audit engagements the long-form report should be submitted in writing to the extent that nothing else has been agreed to. Verbal statements and information provided by the Wirtschaftsprüfer's staff beyond the engagement agreed to are never binding.

6. Protection of the Wirtschaftsprüfer's intellectual property

The client guarantees that expert opinions, organizational charts, drafts, sketches, schedules and calculations – especially quantity and cost computations – prepared by the Wirtschaftsprüfer within the scope of the engagement will be used only for his own purposes.

7. Transmission of the Wirtschaftsprüfer's professional statement

(1) The transmission of a Wirtschaftsprüfer's professional statements (long-form reports, expert opinions and the like) to a third party requires the Wirtschaftsprüfer's written consent to the extent that the permission to transmit to a certain third party does not result from the engagement terms.

The Wirtschaftsprüfer is liable (within the limits of No. 9) towards third parties only if the prerequisites of the first sentence are given.

(2) The use of the Wirtschaftsprüfer's professional statements for promotional purposes is not permitted; an infringement entitles the Wirtschaftsprüfer to immediately cancel all engagements not yet conducted for the client.

8. Correction of deficiencies

(1) Where there are deficiencies, the client is entitled to subsequent fulfillment [of the contract]. The client may demand a reduction in fees or the cancellation of the contract only for the failure to subsequently fulfill [the contract]; if the engagement was awarded by a person carrying on a commercial business as part of that commercial business, a government-owned legal person under public law or a special government-owned fund under public law, the client may demand the cancellation of the contract only if the services rendered are of no interest to him due to the failure to subsequently fulfill [the contract]. No. 9 applies to the extent that claims for damages exist beyond this.

(2) The client must assert his claim for the correction of deficiencies in writing without delay. Claims pursuant to the first paragraph not arising from an intentional tort cease to be enforceable one year after the commencement of the statutory time limit for enforcement.

(3) Obvious deficiencies, such as typing and arithmetical errors and formelle Mängel [deficiencies associated with technicalities] contained in a Wirtschaftsprüfer's professional statements (long-form reports, expert opinions and the like) may be corrected – and also be applicable versus third parties – by the Wirtschaftsprüfer at any time. Errors which may call into question the conclusions contained in the Wirtschaftsprüfer's professional statements entitle the Wirtschaftsprüfer to withdraw – also versus third parties – such statements. In the cases noted the Wirtschaftsprüfer should first hear the client, if possible.

9. Liability

(1) *The liability limitation of § ["Article"] 323 (2) ["paragraph 2"] HGB ["Handelsgesetzbuch": German Commercial Code] applies to statutory audits required by law.*

(2) *Liability for negligence; An individual case of damages*

If neither No. 1 is applicable nor a regulation exists in an individual case, pursuant to § 54a (1) no. 2 WPO ["Wirtschaftsprüferordnung": Law regulating the Profession of Wirtschaftsprüfer] the liability of the Wirtschaftsprüfer for claims of compensatory damages of any kind – except for damages resulting from injury to life, body or health – for an individual case of damages resulting from negligence is limited to € 4 million; this also applies if liability to a person other than the client should be established. An individual case of damages also exists in relation to a uniform damage arising from a number of breaches of duty. The individual case of damages encompasses all consequences from a breach of duty without taking into account whether the damages occurred in one year or in a number of successive years. In this case multiple acts or omissions of acts based on a similar source of error or on a source of error of an equivalent nature are deemed to be a uniform breach of duty if the matters in question are legally or economically connected to one another. In this event the claim against the Wirtschaftsprüfer is limited to € 5 million. The limitation to the fivefold of the minimum amount insured does not apply to compulsory audits required by law.

(3) *Preclusive deadlines*

A compensatory damages claim may only be lodged within a preclusive deadline of one year of the rightful claimant having become aware of the damage and of the event giving rise to the claim – at the very latest, however, within 5 years subsequent to the event giving rise to the claim. The claim expires if legal action is not taken within a six month deadline subsequent to the written refusal of acceptance of the indemnity and the client was informed of this consequence.

The right to assert the bar of the preclusive deadline remains unaffected. Sentences 1 to 3 also apply to legally required audits with statutory liability limits.

10. Supplementary provisions for audit engagements

(1) A subsequent amendment or abridgement of the financial statements or management report audited by a Wirtschaftsprüfer and accompanied by an auditor's report requires the written consent of the Wirtschaftsprüfer even if these documents are not published. If the Wirtschaftsprüfer has not issued an auditor's report, a reference to the audit conducted by the Wirtschaftsprüfer in the management report or elsewhere specified for the general public is permitted only with the Wirtschaftsprüfer's written consent and using the wording authorized by him.

(2) If the Wirtschaftsprüfer revokes the auditor's report, it may no longer be used. If the client has already made use of the auditor's report, he must announce its revocation upon the Wirtschaftsprüfer's request.

(3) The client has a right to 5 copies of the long-form report. Additional copies will be charged for separately.

11. Supplementary provisions for assistance with tax matters

(1) When advising on an individual tax issue as well as when furnishing continuous tax advice, the Wirtschaftsprüfer is entitled to assume that the facts provided by the client – especially numerical disclosures – are correct and complete; this also applies to bookkeeping engagements. Nevertheless, he is obliged to inform the client of any errors he has discovered.

(2) The tax consulting engagement does not encompass procedures required to meet deadlines, unless the Wirtschaftsprüfer has explicitly accepted the engagement for this. In this event the client must provide the Wirtschaftsprüfer, on a timely basis, all supporting documents and records – especially tax assessments – material to meeting the deadlines, so that the Wirtschaftsprüfer has an appropriate time period available to work therewith.

(3) In the absence of other written agreements, continuous tax advice encompasses the following work during the contract period:

- a) preparation of annual tax returns for income tax, corporation tax and business tax, as well as net worth tax returns on the basis of the annual financial statements and other schedules and evidence required for tax purposes to be submitted by the client
- b) examination of tax assessments in relation to the taxes mentioned in (a)
- c) negotiations with tax authorities in connection with the returns and assessments mentioned in (a) and (b)
- d) participation in tax audits and evaluation of the results of tax audits with respect to the taxes mentioned in (a)
- e) participation in Einspruchs- und Beschwerdeverfahren [appeals and complaint procedures] with respect to the taxes mentioned in (a).

In the afore-mentioned work the Wirtschaftsprüfer takes material published legal decisions and administrative interpretations into account.

(4) If the Wirtschaftsprüfer receives a fixed fee for continuous tax advice, in the absence of other written agreements the work mentioned under paragraph 3 (d) and (e) will be charged separately.

(5) Services with respect to special individual issues for income tax, corporate tax, business tax, valuation procedures for property and net worth taxation, and net worth tax as well as all issues in relation to sales tax, wages tax, other taxes and dues require a special engagement. This also applies to:

- a) the treatment of nonrecurring tax matters, e. g. in the field of estate tax, capital transactions tax, real estate acquisition tax
- b) participation and representation in proceedings before tax and administrative courts and in criminal proceedings with respect to taxes, and
- c) the granting of advice and work with respect to expert opinions in connection with conversions of legal form, mergers, capital increases and reductions, financial reorganizations, admission and retirement of partners or shareholders, sale of a business, liquidations and the like.

(6) To the extent that the annual sales tax return is accepted as additional work, this does not include the review of any special accounting prerequisites nor of the issue as to whether all potential legal sales tax reductions have been claimed. No guarantee is assumed for the completeness of the supporting documents and records to validate the deduction of the input tax credit.

12. Confidentiality towards third parties and data security

(1) Pursuant to the law the Wirtschaftsprüfer is obliged to treat all facts that he comes to know in connection with his work as confidential, irrespective of whether these concern the client himself or his business associations, unless the client releases him from this obligation.

(2) The Wirtschaftsprüfer may only release long-form reports, expert opinions and other written statements on the results of his work to third parties with the consent of his client.

(3) The Wirtschaftsprüfer is entitled – within the purposes stipulated by the client – to process personal data entrusted to him or allow them to be processed by third parties.

13. Default of acceptance and lack of cooperation on the part of the client

If the client defaults in accepting the services offered by the Wirtschaftsprüfer or if the client does not provide the assistance incumbent on him pursuant to No. 3 or otherwise, the Wirtschaftsprüfer is entitled to cancel the contract immediately. The Wirtschaftsprüfer's right to compensation for additional expenses as well as for damages caused by the default or the lack of assistance is not affected, even if the Wirtschaftsprüfer does not exercise his right to cancel.

14. Remuneration

(1) In addition to his claims for fees or remuneration, the Wirtschaftsprüfer is entitled to reimbursement of his outlays: sales tax will be billed separately. He may claim appropriate advances for remuneration and reimbursement of outlays and make the rendering of his services dependent upon the complete satisfaction of his claims. Multiple clients awarding engagements are jointly and severally liable.

(2) Any set off against the Wirtschaftsprüfer's claims for remuneration and reimbursement of outlays is permitted only for undisputed claims or claims determined to be legally valid.

15. Retention and return of supporting documentation and records

(1) The Wirtschaftsprüfer retains, for ten years, the supporting documents and records in connection with the completion of the engagement – that had been provided to him and that he has prepared himself – as well as the correspondence with respect to the engagement.

(2) After the settlement of his claims arising from the engagement, the Wirtschaftsprüfer, upon the request of the client, must return all supporting documents and records obtained from him or for him by reason of his work on the engagement. This does not, however, apply to correspondence exchanged between the Wirtschaftsprüfer and his client and to any documents of which the client already has the original or a copy. The Wirtschaftsprüfer may prepare and retain copies or photocopies of supporting documents and records which he returns to the client.

16. Applicable law

Only German law applies to the engagement, its conduct and any claims arising therefrom.